

Cardiovascular Instruments  
胸腔心血管

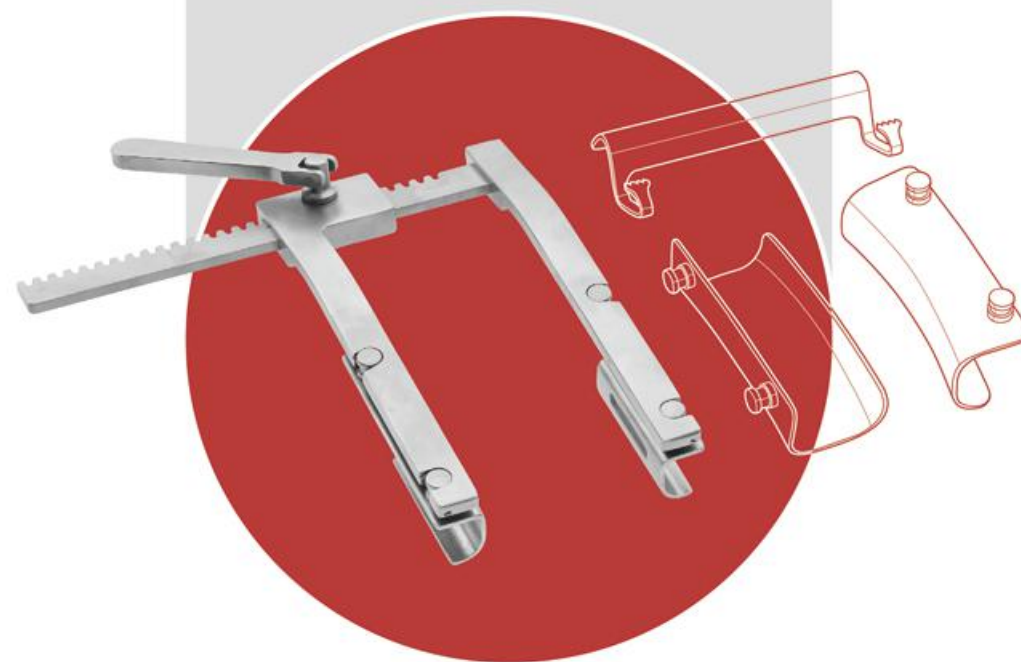

QUALITY  
OUR WAY TO SUCCESS

Cardiovascular Instruments



心脏手术剪  
Vessel scissors  
**ZL1804RB**  
190×25°  
**ZL1805RB**  
190×40°

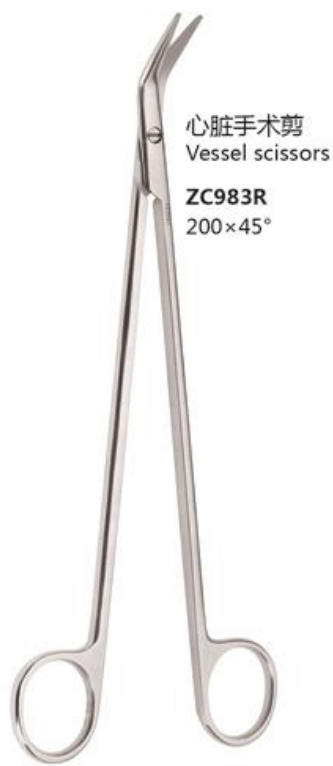

心脏手术剪  
Vessel scissors  
**ZC983R**  
200×45°



肋骨剪  
Rib shears  
**ZL870R**  
220



肋骨剪  
Rib shears, right



**ZL876R**  
340, 右式



**ZL877R**  
340, 左式



**ZL878R**  
340



心脏手术剪  
Vessel scissors  
**ZC810RG**  
250, 瓣膜



双关节肋骨咬骨钳  
Double joint rib rongeur  
straight  
**ZL572R**  
300×22, 直



双关节肋骨咬骨钳  
Double joint rib rongeur  
straight  
**ZL573R**  
300×22, 弯

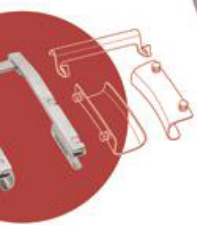

胸腔心血管  
Cardiovascular Instruments



胸腔心血管  
Cardiovascular Instruments



自锁簧式持针钳  
(显微持针钳)  
Needle holder with self-catch  
straight

**ZF094RG**  
200×1.5, 直型



自锁簧式持针钳  
(显微持针钳)  
Needle holder with self-catch  
straight

**ZF094T**  
200×1.5, 直型



自锁簧式持针钳  
(显微持针钳)  
Needle holder with self-catch  
straight

**ZF095RG**  
200×1.5, 弯型



自锁簧式持针钳  
(显微持针钳)  
Needle holder with self-catch  
straight

**ZF249RG**  
225×0.8 弯型



自锁簧式持针钳  
(显微持针钳)  
Needle holder with self-catch  
curved

**ZF249T**  
225×0.8 弯型



胸腔组织钳  
Tissue grasping forceps

**ZE026R**  
200  
**ZE026RN**  
200

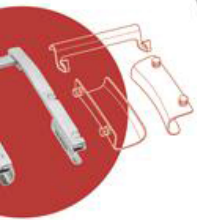

胸腔心血管  
Cardiovascular Instruments

胸腔心血管  
Cardiovascular Instruments



自锁簧式持针钳  
(显微持针钳)  
Needle holder with self-catch  
straight

**ZF095T**  
200×1.5, 弯型



自锁簧式持针钳  
(显微持针钳)  
Needle holder with self-catch  
straight

**ZF248RG**  
225×0.8 直型



自锁簧式持针钳  
(显微持针钳)  
Needle holder with self-catch  
straight

**ZF248T**  
225×0.8 直型



胸腔组织钳  
Tissue grasping forceps

**ZE027RN**  
200, 精细



胸腔止血钳  
Dissecting and ligature forceps

**ZE101R**  
200×2.7, 圆弯R45×10 (微弯)  
**ZE104R**  
220×2.7, 圆弯R65×10 (微弯)  
**ZE108R**  
250×2.7, 圆弯R65×9 (微弯)



胸腔止血钳  
Dissecting and ligature forceps

**ZE100R**  
200×2.7, 圆弯R22×15 (中弯)  
**ZE105R**  
220×2.7, 圆弯R32×15 (中弯)  
**ZE103R**  
250×2.7, 圆弯R32×15 (中弯)  
**ZE103RN**  
250×2.7, 圆弯R32×15 (中弯)



胸腔止血钳  
Dissecting and ligature forceps

- ZE107R**  
200×2.7, 圆弯R22×20 (大弯)
- ZE106R**  
220×2.7, 圆弯R22×20 (大弯)
- ZE102R**  
250×2.7, 圆弯R22×22 (大弯)
- ZE102RN**  
250×2.7, 圆弯R22×22 (大弯)

直角钳  
Dissecting and ligature forceps

- ZH230RB**  
130×13
- ZH231RB**  
180×15
- ZH234RB**  
200×16

直角钳  
Dissecting and ligature forceps

- ZE086RG**  
135×6×1.8
- ZE088RG**  
170×12×2
- ZE089RG**  
200×14×2.2



直角气管钳  
Bronchus forceps, right angled

- ZL950R**  
180×2.8×30, 竖齿
- ZL950RN**  
180×2.8×30, 竖齿

直角气管钳  
Bronchus forceps, right angled

- ZL951R**  
220×4×45
- ZL951RN**  
220×4×45

肺叶钳  
Lung grasping forceps

- ZE041R**  
160×13.5, 三角头

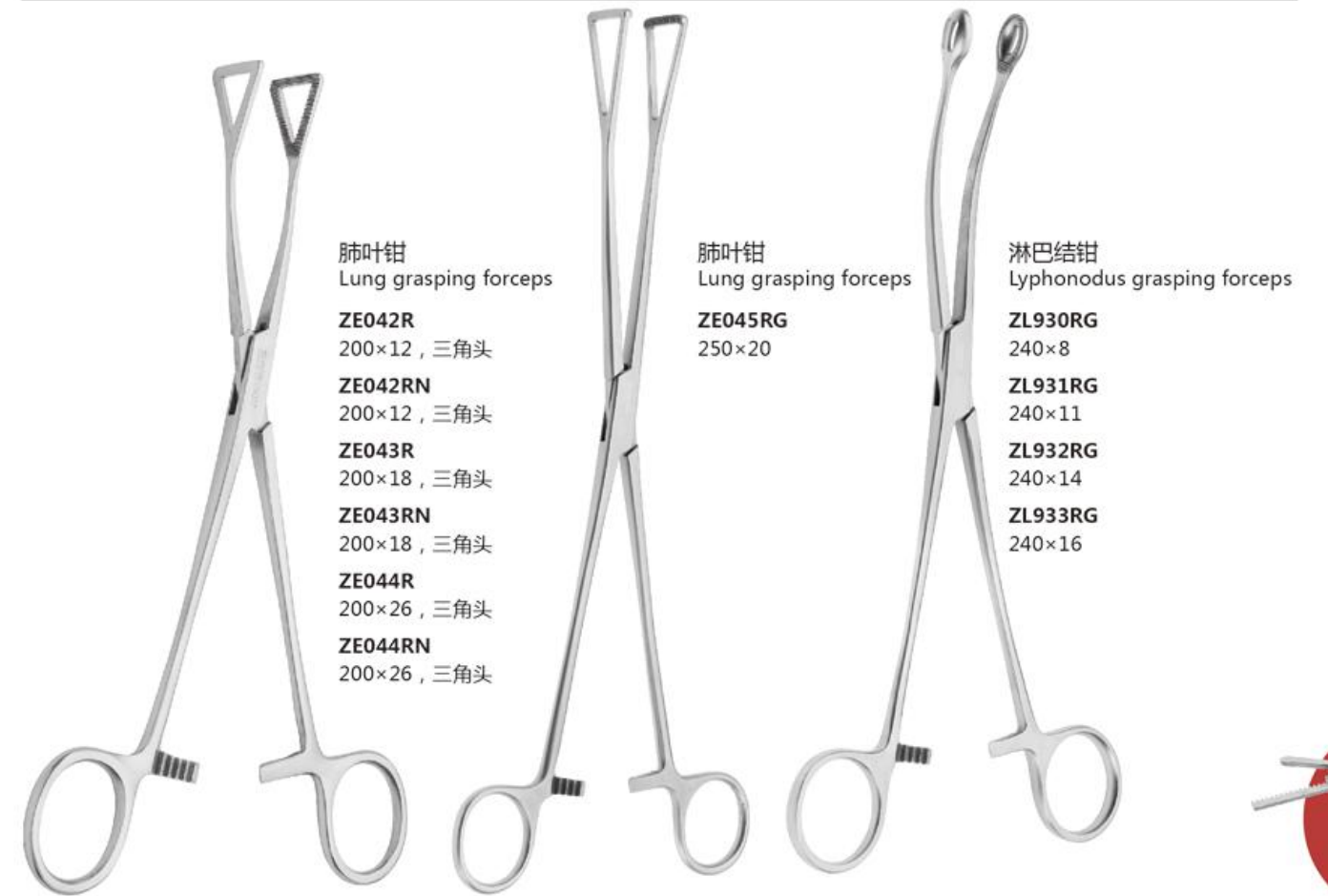

肺叶钳  
Lung grasping forceps

- ZE042R**  
200×12, 三角头
- ZE042RN**  
200×12, 三角头
- ZE043R**  
200×18, 三角头
- ZE043RN**  
200×18, 三角头
- ZE044R**  
200×26, 三角头
- ZE044RN**  
200×26, 三角头

肺叶钳  
Lung grasping forceps

- ZE045RG**  
250×20

淋巴结钳  
Lymphonodus grasping forceps

- ZL930RG**  
240×8
- ZL931RG**  
240×11
- ZL932RG**  
240×14
- ZL933RG**  
240×16



钢丝结扎钳  
Wire holder

- ZK488RG**  
135
- ZK489RG**  
150
- ZK492RG**  
160
- ZK491RG**  
180
- ZK493RG**  
200

管道钳 (皮管钳)  
Tubing clamp

- ZL615RG**  
160×28
- ZL619RG**  
180×45
- ZL616R**  
190×45
- ZL617RG**  
200×45
- ZL618RG**  
220×60

套管束紧钳  
Vascular clamp

- ZL500RG**  
140×4×17, 角弯75°, 弯柄, 网纹齿
- ZL501RG**  
200×5×20, 角弯60°, 弯柄, 网纹齿



胸腔心血管  
Cardiovascular Instruments



纱布剥离钳  
Vascular clamp  
**ZL630R**  
240  
**ZL630RN**  
240

血管结扎钳  
Dissecting and ligature forceps  
**ZE090R**  
220×3.4, 圆弯R12×16, 竖齿3×4  
**ZE090RN**  
220×3.4, 圆弯R12×16, 竖齿3×4

血管结扎钳  
Dissecting and ligature forceps  
**ZE091R**  
220×3.4, 圆弯R8×18, 横齿



血管游离钳  
Vascular dissecting clamp  
**ZL642R**  
III式, 230×3.6, 头圆弯R11×21  
**ZL642RG**  
III式, 230×3.6, 头圆弯R11×21

血管游离钳  
Vascular dissecting clamp  
**ZL641R**  
II式, 230×3.6, 头圆弯R14×27  
**ZL641RG**  
II式, 230×3.6, 头圆弯R14×27

血管游离钳  
Vascular dissecting clamp  
**ZL640R**  
I式, 230×3.6, 头圆弯R17×32  
**ZL640RG**  
I式, 230×3.6, 头圆弯R17×32



胸腔心血管  
Cardiovascular Instruments

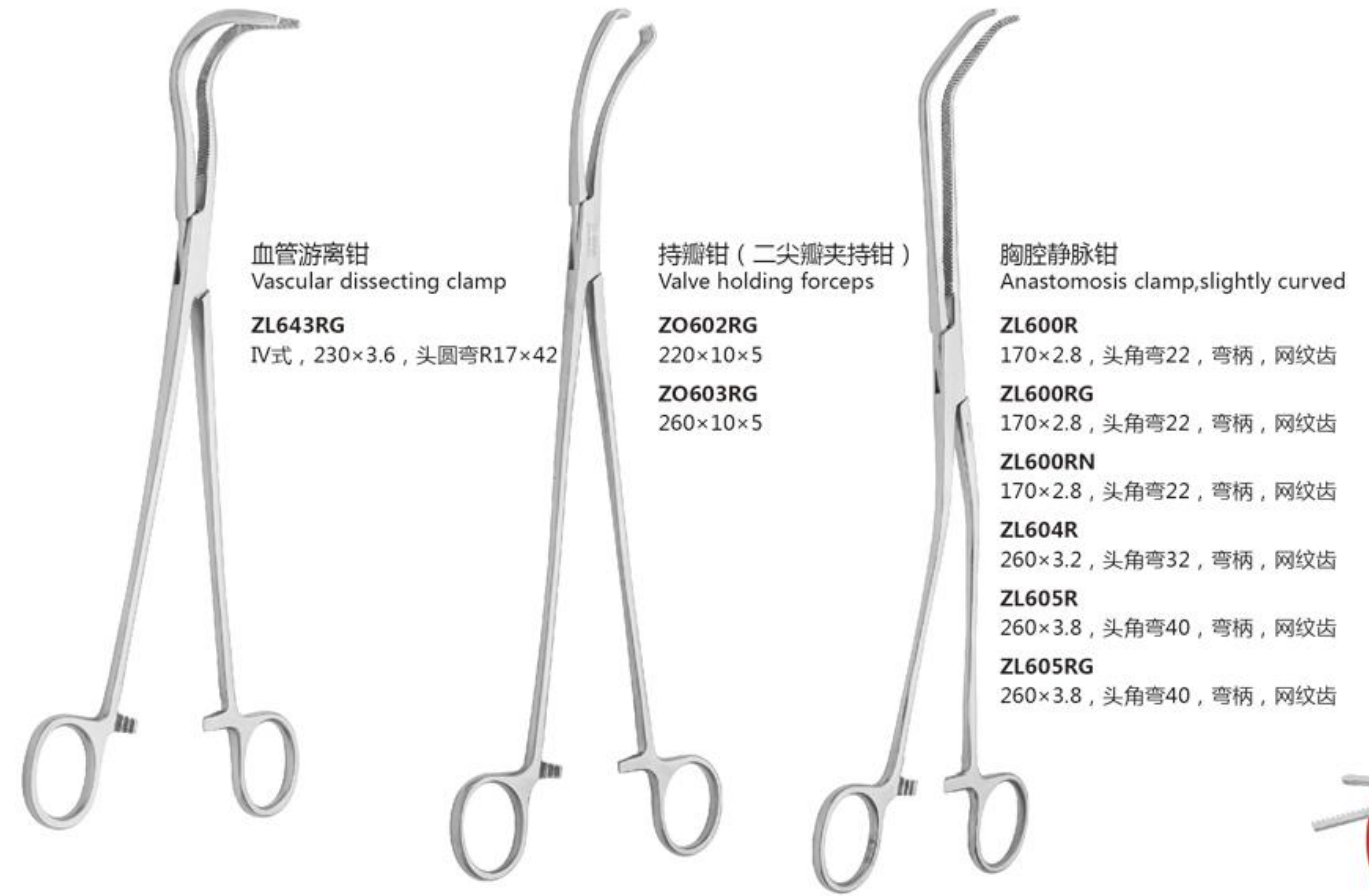

血管游离钳  
Vascular dissecting clamp  
**ZL643RG**  
IV式, 230×3.6, 头圆弯R17×42

持瓣钳 (二尖瓣夹持钳)  
Valve holding forceps  
**ZO602RG**  
220×10×5  
**ZO603RG**  
260×10×5

胸腔静脉钳  
Anastomosis clamp, slightly curved  
**ZL600R**  
170×2.8, 头角弯22, 弯柄, 网纹齿  
**ZL600RG**  
170×2.8, 头角弯22, 弯柄, 网纹齿  
**ZL600RN**  
170×2.8, 头角弯22, 弯柄, 网纹齿  
**ZL604R**  
260×3.2, 头角弯32, 弯柄, 网纹齿  
**ZL605R**  
260×3.8, 头角弯40, 弯柄, 网纹齿  
**ZL605RG**  
260×3.8, 头角弯40, 弯柄, 网纹齿

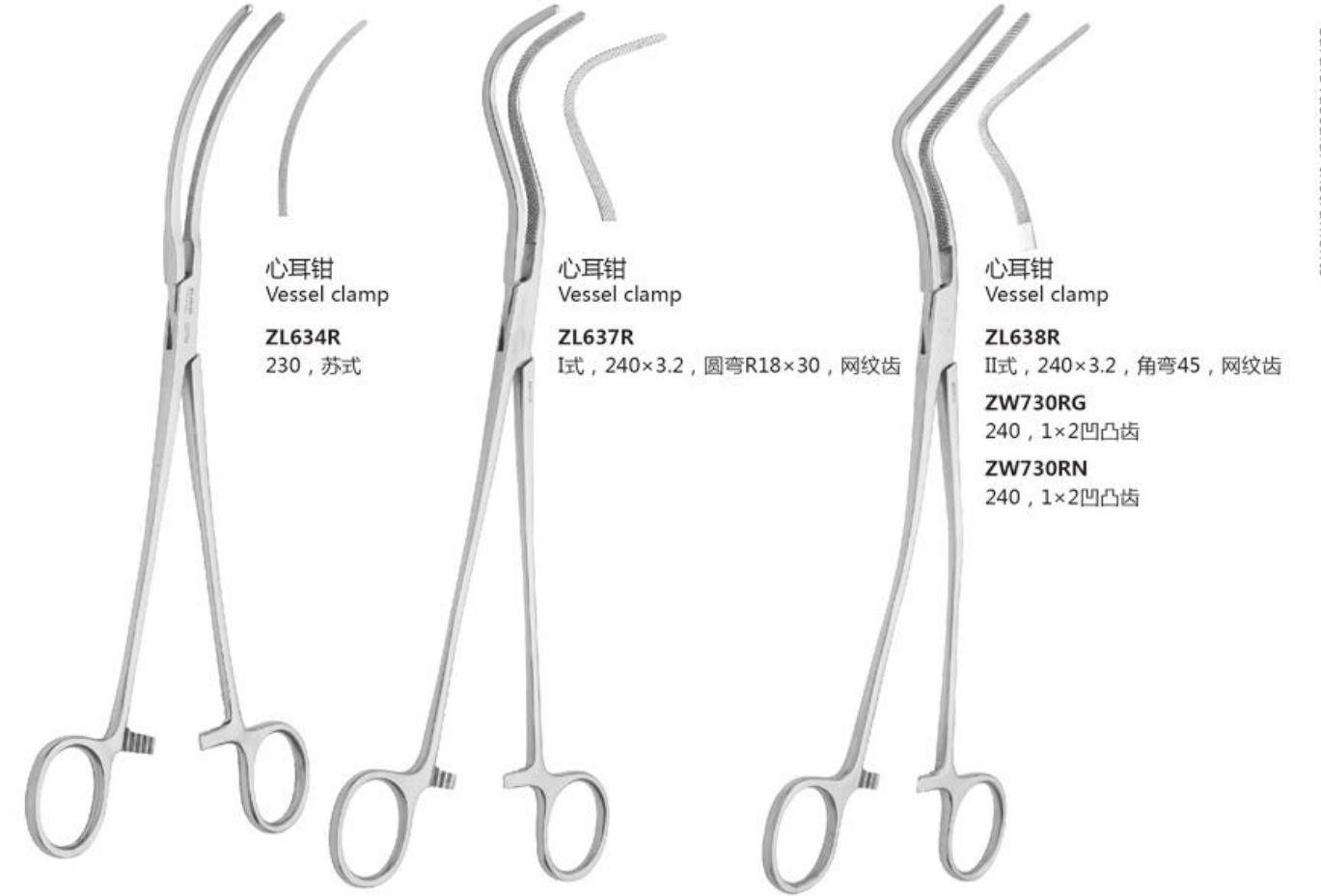

心耳钳  
Vessel clamp  
**ZL634R**  
230, 苏式

心耳钳  
Vessel clamp  
**ZL637R**  
I式, 240×3.2, 圆弯R18×30, 网纹齿

心耳钳  
Vessel clamp  
**ZL638R**  
II式, 240×3.2, 角弯45, 网纹齿  
**ZW730RG**  
240, 1×2凹凸齿  
**ZW730RN**  
240, 1×2凹凸齿



心耳钳  
Vessel clamp

**ZL639R**  
III式, 240×3.2  
角弯36, 网纹齿  
**ZL639RN**  
III式, 240×3.2  
角弯36, 网纹齿  
**ZL1799RB**  
240×38, 1×2凹凸齿

主动脉侧壁钳  
Peripheral  
vascular clamp

**ZL1401RB**  
190×Φ5

主动脉侧壁钳  
Peripheral  
vascular clamp

**ZL1402RB**  
a  
160×18  
**ZL1403RB**  
170×22  
**ZW726RG**  
170  
**ZL1404RB**  
180×30  
**ZL1550RB**  
180×30 双齿



主动脉侧壁钳  
Peripheral vascular clamp

**ZL1405RB**  
a  
140×20 双齿

主动脉侧壁钳  
Peripheral vascular clamp

**ZL1406RB**  
a  
170×25

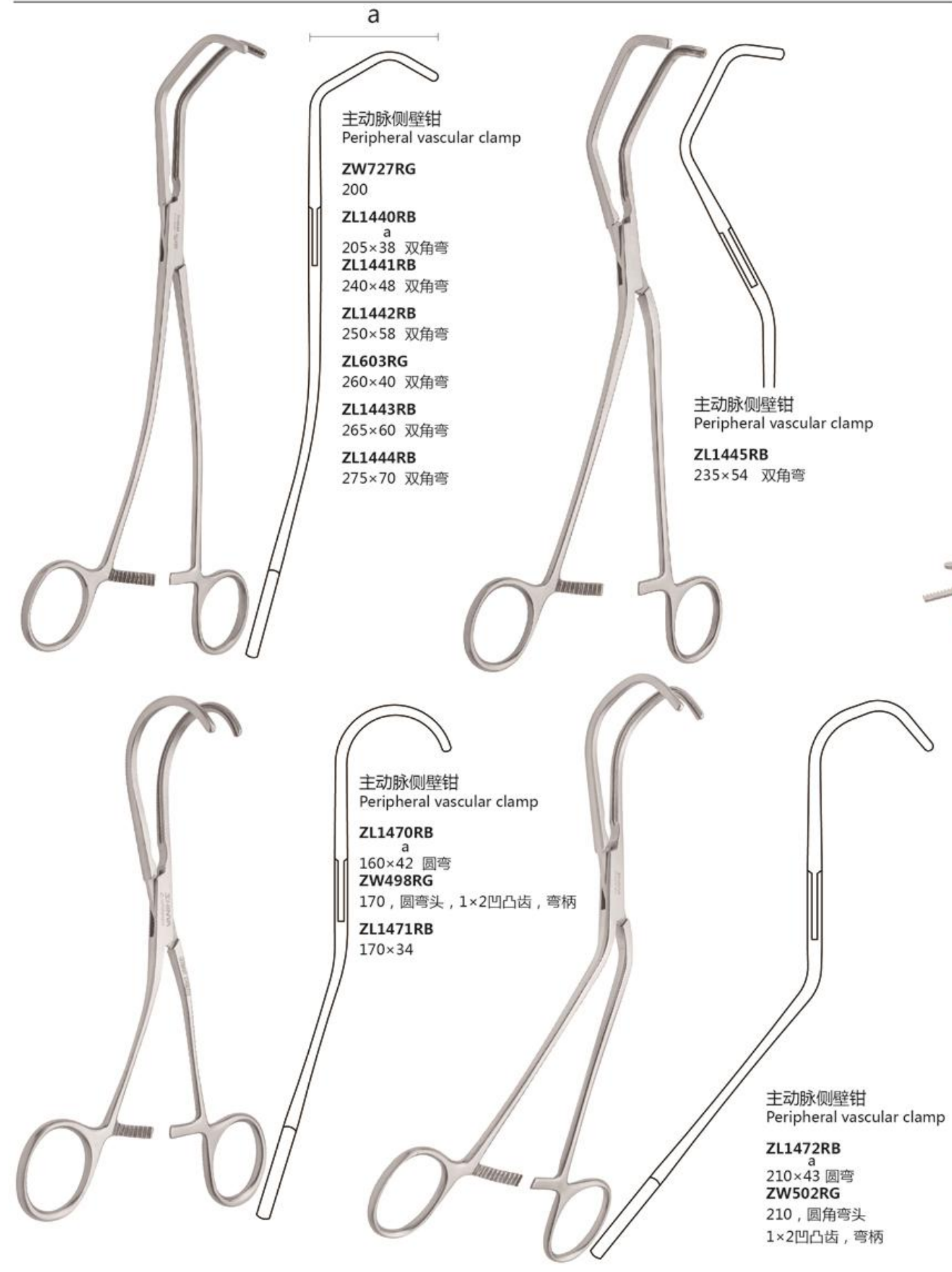

主动脉侧壁钳  
Peripheral vascular clamp

**ZW727RG**  
200  
**ZL1440RB**  
a  
205×38 双角弯  
**ZL1441RB**  
240×48 双角弯  
**ZL1442RB**  
250×58 双角弯  
**ZL603RG**  
260×40 双角弯  
**ZL1443RB**  
265×60 双角弯  
**ZL1444RB**  
275×70 双角弯

主动脉侧壁钳  
Peripheral vascular clamp

**ZL1445RB**  
235×54 双角弯

主动脉侧壁钳  
Peripheral vascular clamp

**ZL1470RB**  
a  
160×42 圆弯  
**ZW498RG**  
170, 圆弯头, 1×2凹凸齿, 弯柄  
**ZL1471RB**  
170×34

主动脉侧壁钳  
Peripheral vascular clamp

**ZL1472RB**  
a  
210×43 圆弯  
**ZW502RG**  
210, 圆角弯头  
1×2凹凸齿, 弯柄

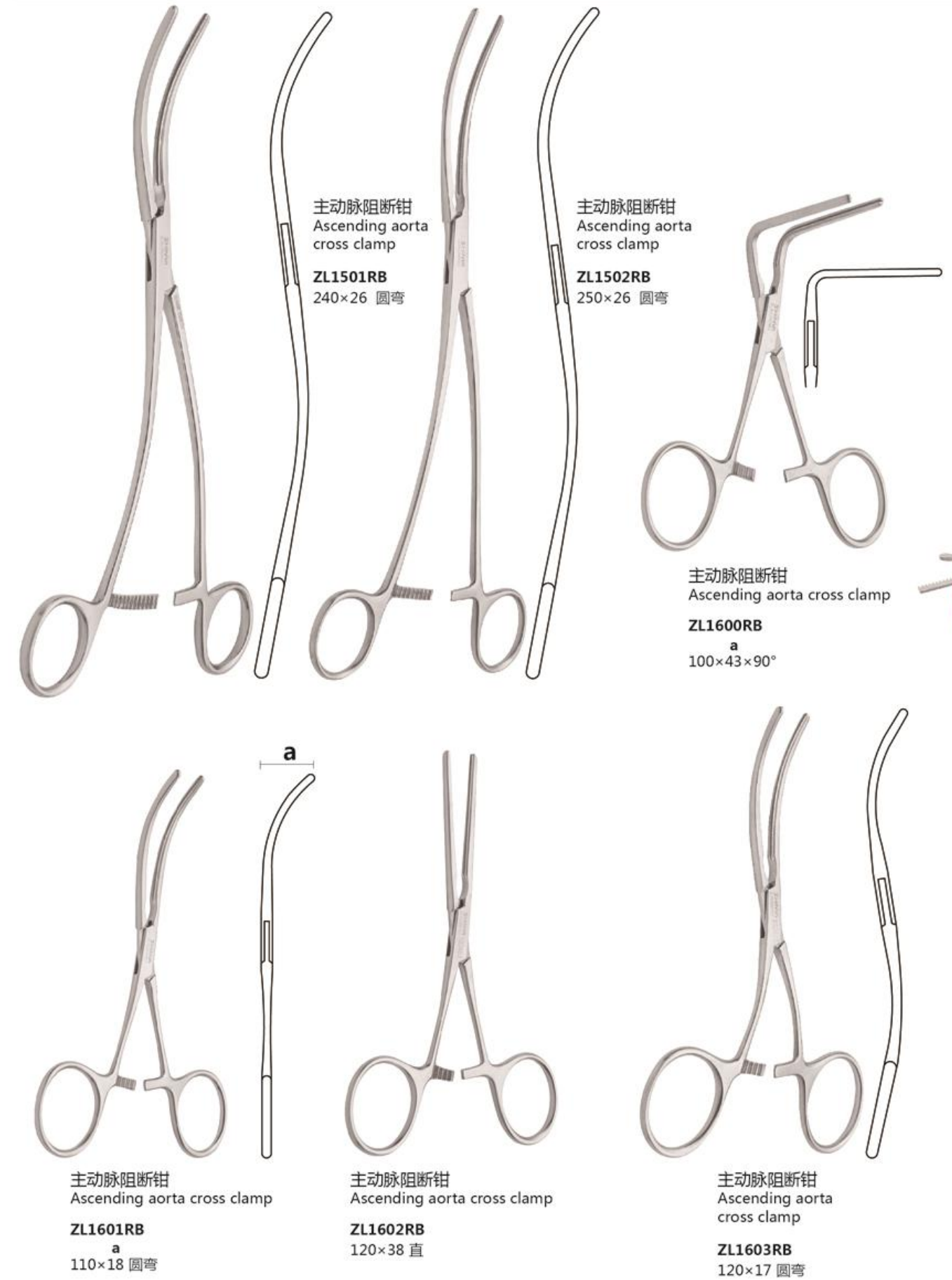
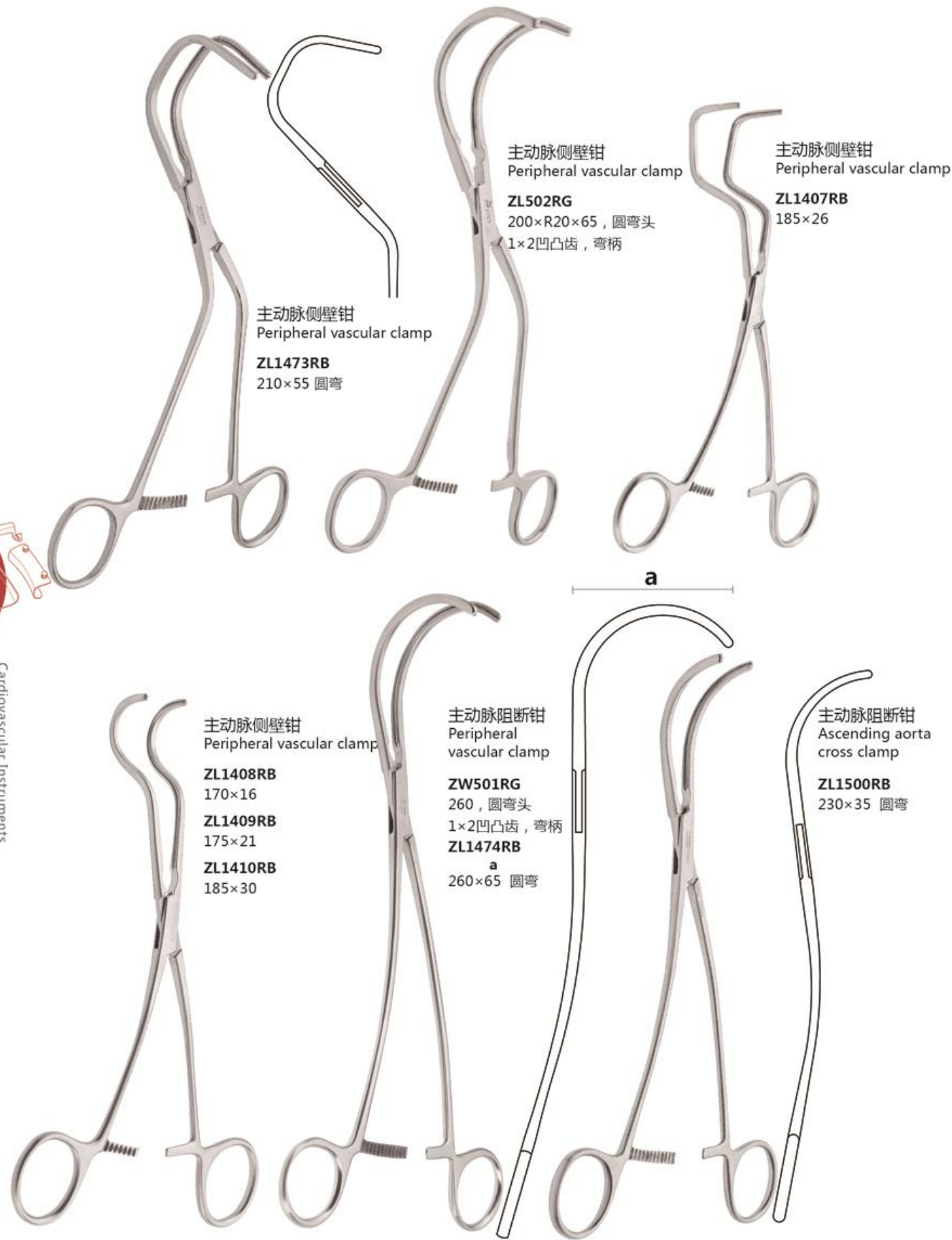

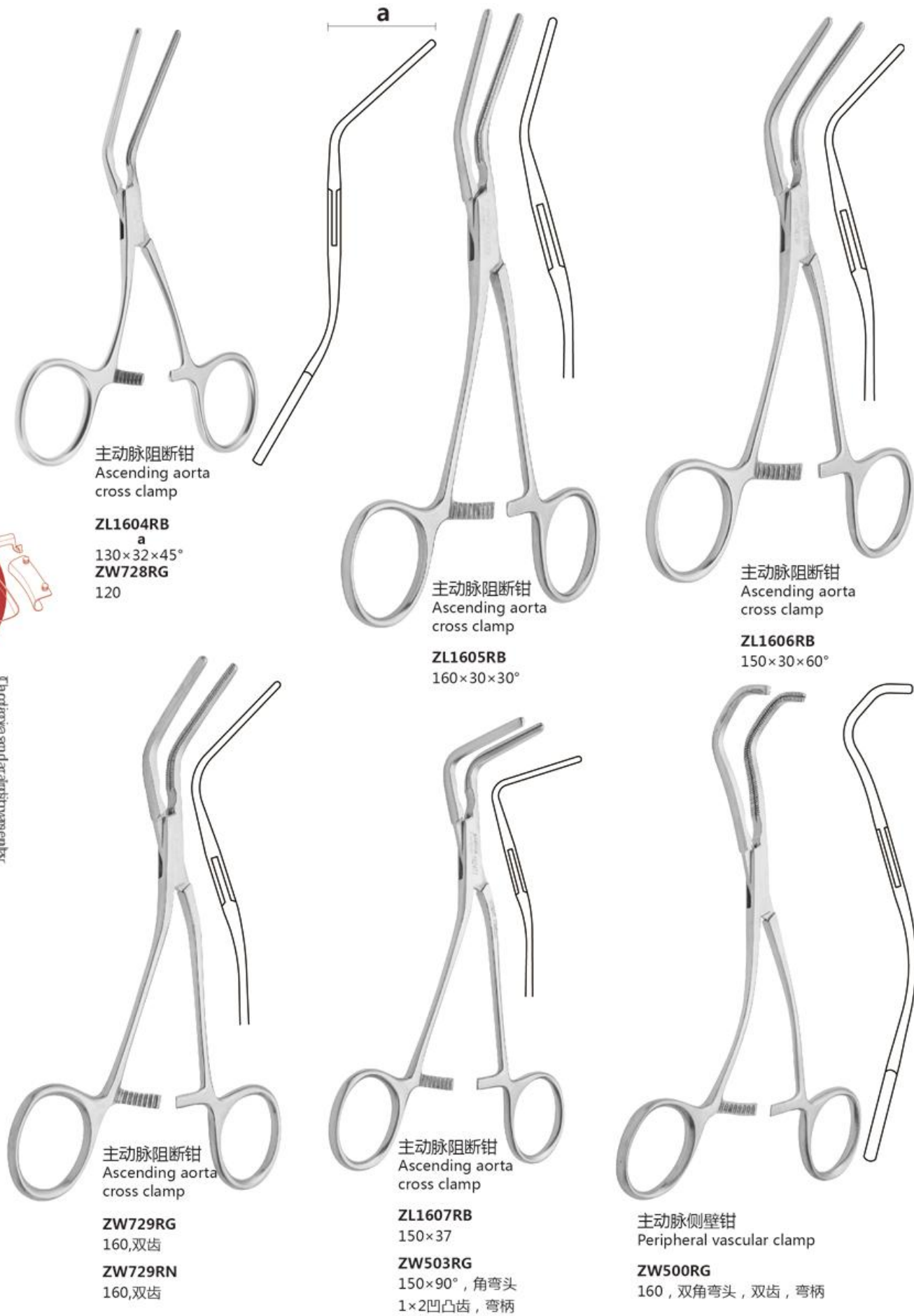

主动脉阻断钳  
Ascending aorta  
cross clamp

**ZL1604RB**  
a  
130×32×45°  
**ZW728RG**  
120

主动脉阻断钳  
Ascending aorta  
cross clamp

**ZL1605RB**  
160×30×30°

主动脉阻断钳  
Ascending aorta  
cross clamp

**ZL1606RB**  
150×30×60°

主动脉阻断钳  
Ascending aorta  
cross clamp

**ZW729RG**  
160,双齿  
**ZW729RN**  
160,双齿

主动脉阻断钳  
Ascending aorta  
cross clamp

**ZL1607RB**  
150×37  
**ZW503RG**  
150×90°,角弯头  
1×2凹凸齿,弯柄

主动脉侧壁钳  
Peripheral vascular clamp

**ZW500RG**  
160,双角弯头,双齿,弯柄

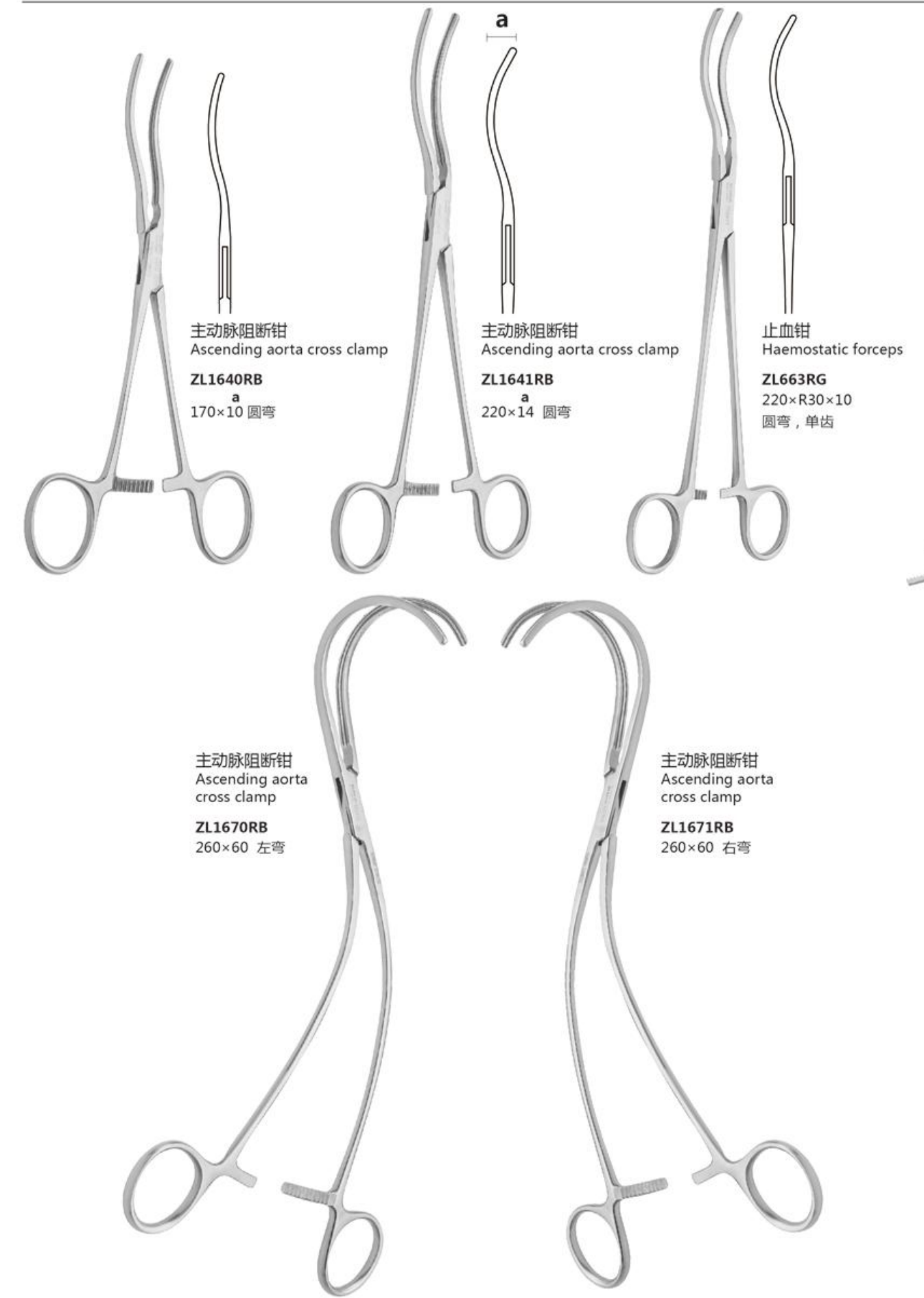

主动脉阻断钳  
Ascending aorta cross clamp

**ZL1640RB**  
a  
170×10 圆弯

主动脉阻断钳  
Ascending aorta cross clamp

**ZL1641RB**  
a  
220×14 圆弯

止血钳  
Haemostatic forceps

**ZL663RG**  
220×R30×10  
圆弯,单齿

主动脉阻断钳  
Ascending aorta  
cross clamp

**ZL1670RB**  
260×60 左弯

主动脉阻断钳  
Ascending aorta  
cross clamp

**ZL1671RB**  
260×60 右弯





胸腔心血管  
Cardiovascular Instruments

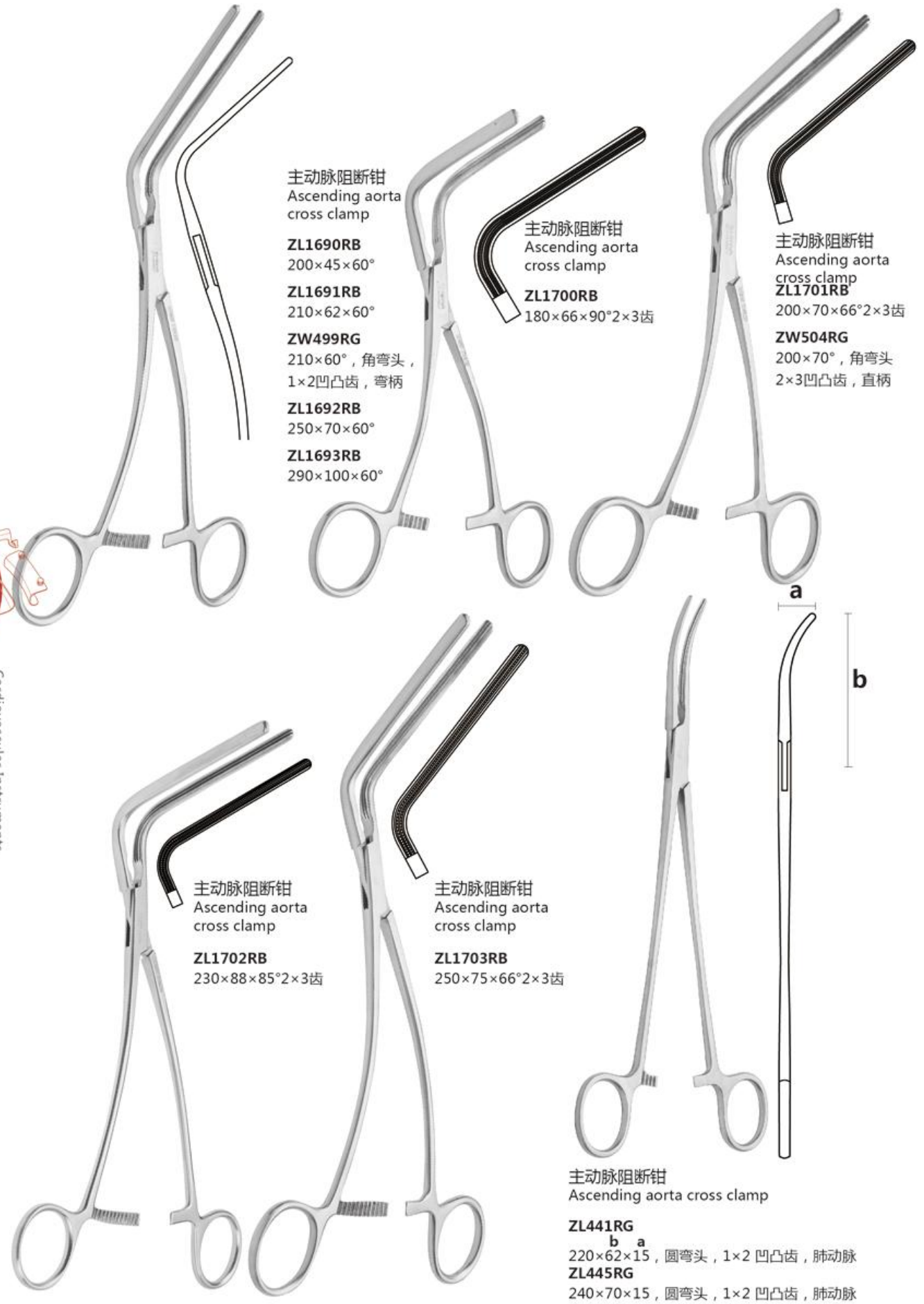

主动脉阻断钳  
Ascending aorta cross clamp  
**ZL1690RB**  
200×45×60°  
**ZL1691RB**  
210×62×60°  
**ZW499RG**  
210×60°, 角弯头,  
1×2凹凸齿, 弯柄  
**ZL1692RB**  
250×70×60°  
**ZL1693RB**  
290×100×60°

主动脉阻断钳  
Ascending aorta cross clamp  
**ZL1700RB**  
180×66×90°2×3齿

主动脉阻断钳  
Ascending aorta cross clamp  
**ZL1701RB**  
200×70×66°2×3齿  
**ZW504RG**  
200×70°, 角弯头  
2×3凹凸齿, 直柄

主动脉阻断钳  
Ascending aorta cross clamp  
**ZL1702RB**  
230×88×85°2×3齿

主动脉阻断钳  
Ascending aorta cross clamp  
**ZL1703RB**  
250×75×66°2×3齿

主动脉阻断钳  
Ascending aorta cross clamp  
**ZL441RG**  
220×62×15, 圆弯头, 1×2凹凸齿, 肺动脉  
**ZL445RG**  
240×70×15, 圆弯头, 1×2凹凸齿, 肺动脉



胸腔心血管  
Cardiovascular Instruments

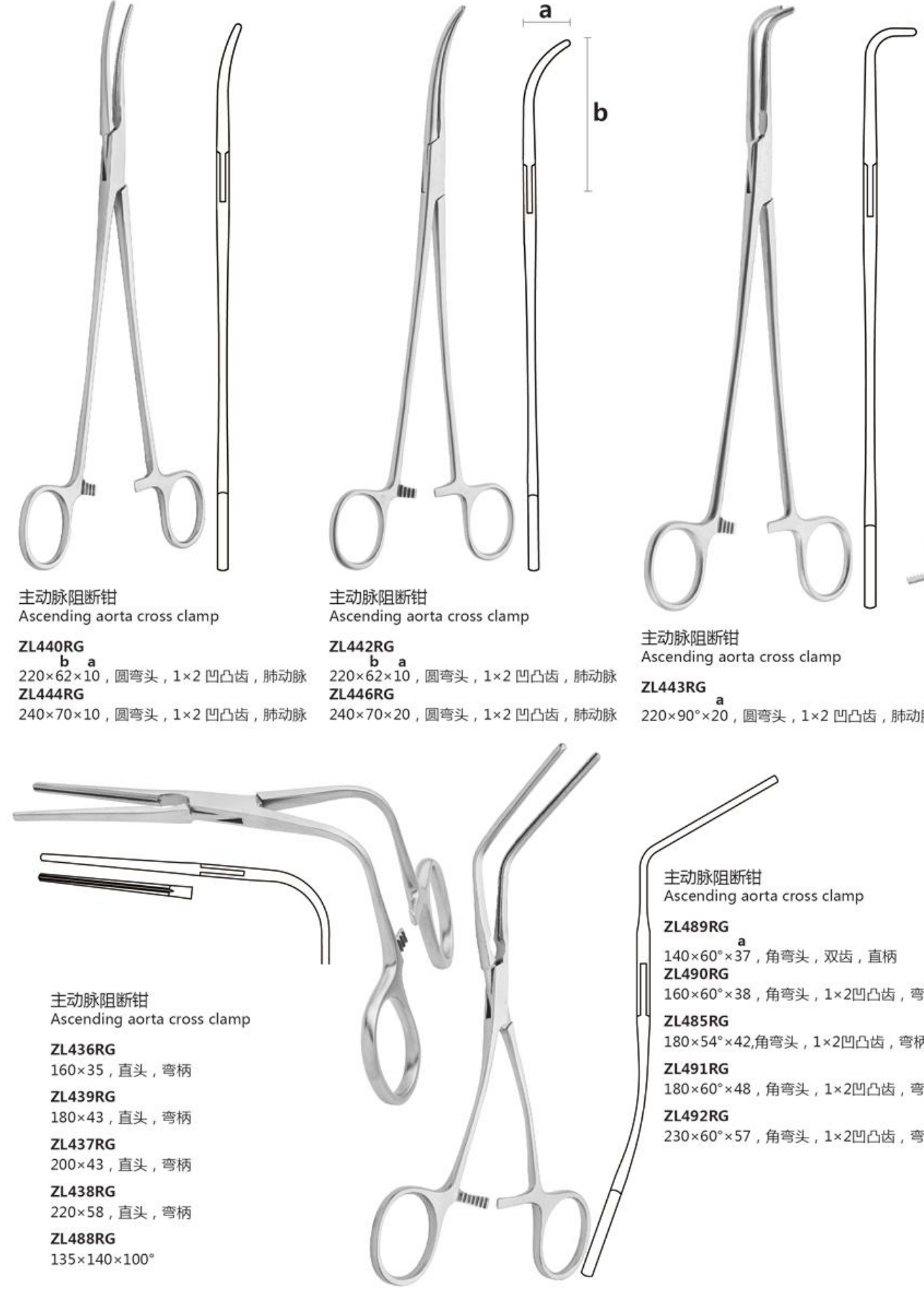

主动脉阻断钳  
Ascending aorta cross clamp  
**ZL440RG**  
220×62×10, 圆弯头, 1×2凹凸齿, 肺动脉  
**ZL444RG**  
240×70×10, 圆弯头, 1×2凹凸齿, 肺动脉

主动脉阻断钳  
Ascending aorta cross clamp  
**ZL442RG**  
220×62×10, 圆弯头, 1×2凹凸齿, 肺动脉  
**ZL446RG**  
240×70×20, 圆弯头, 1×2凹凸齿, 肺动脉

主动脉阻断钳  
Ascending aorta cross clamp  
**ZL443RG**  
220×90°×20, 圆弯头, 1×2凹凸齿, 肺动脉

主动脉阻断钳  
Ascending aorta cross clamp  
**ZL436RG**  
160×35, 直头, 弯柄  
**ZL439RG**  
180×43, 直头, 弯柄  
**ZL437RG**  
200×43, 直头, 弯柄  
**ZL438RG**  
220×58, 直头, 弯柄  
**ZL488RG**  
135×140×100°

主动脉阻断钳  
Ascending aorta cross clamp  
**ZL489RG**  
140×60°×37, 角弯头, 双齿, 直柄  
**ZL490RG**  
160×60°×38, 角弯头, 1×2凹凸齿, 弯柄  
**ZL485RG**  
180×54°×42, 角弯头, 1×2凹凸齿, 弯柄  
**ZL491RG**  
180×60°×48, 角弯头, 1×2凹凸齿, 弯柄  
**ZL492RG**  
230×60°×57, 角弯头, 1×2凹凸齿, 弯柄

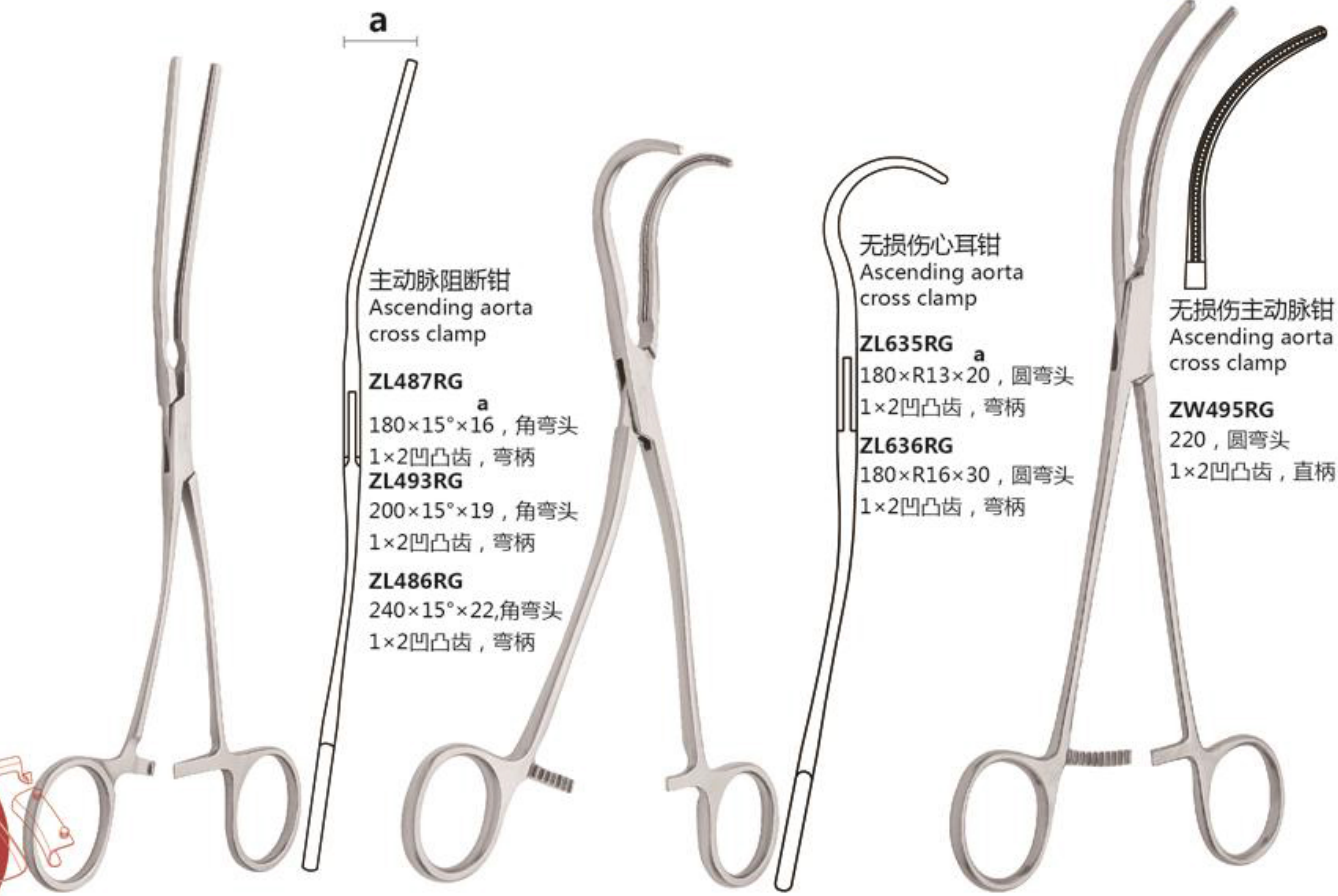

**主动脉阻断钳**  
Ascending aorta cross clamp

**ZL487RG**  
180×15°×16, 角弯头  
1×2凹凸齿, 弯柄

**ZL493RG**  
200×15°×19, 角弯头  
1×2凹凸齿, 弯柄

**ZL486RG**  
240×15°×22, 角弯头  
1×2凹凸齿, 弯柄

**无损伤心耳钳**  
Ascending aorta cross clamp

**ZL635RG**  
180×R13×20, 圆弯头  
1×2凹凸齿, 弯柄

**ZL636RG**  
180×R16×30, 圆弯头  
1×2凹凸齿, 弯柄

**无损伤主动脉钳**  
Ascending aorta cross clamp

**ZW495RG**  
220, 圆弯头  
1×2凹凸齿, 直柄



**主动脉阻断钳**  
Ascending aorta cross clamp

**ZW496RG**  
220, 圆弯头, 1×2凹凸齿  
直柄, 肺动脉

**ZW497RG**  
230, 圆弯头, 1×2凹凸齿  
直柄, 肺动脉

**止血钳**  
Haemostatic forceps

**ZL1551RB**  
200×18 双齿

**止血钳**  
Haemostatic forceps

**ZL562RG**  
200×38°×19, 角弯, 双齿



**止血钳**  
Haemostatic forceps

**ZL1552RB**  
210×60, 直, 弯柄, 双齿

**ZL563RG**  
220, 直, 弯柄, 双齿

**止血钳**  
Haemostatic forceps

**ZL547RG**  
125, 直, 1×2齿

**ZL549RG**  
140, 直, 1×2齿

**ZL551RG**  
160, 直, 1×2齿

**止血钳**  
Haemostatic forceps

**ZL548RG**  
125×25×6, 圆弯, 1×2齿

**ZL550RG**  
140×32×8 圆弯, 1×2齿

**ZL552RG**  
160×35×10, 圆弯, 1×2齿

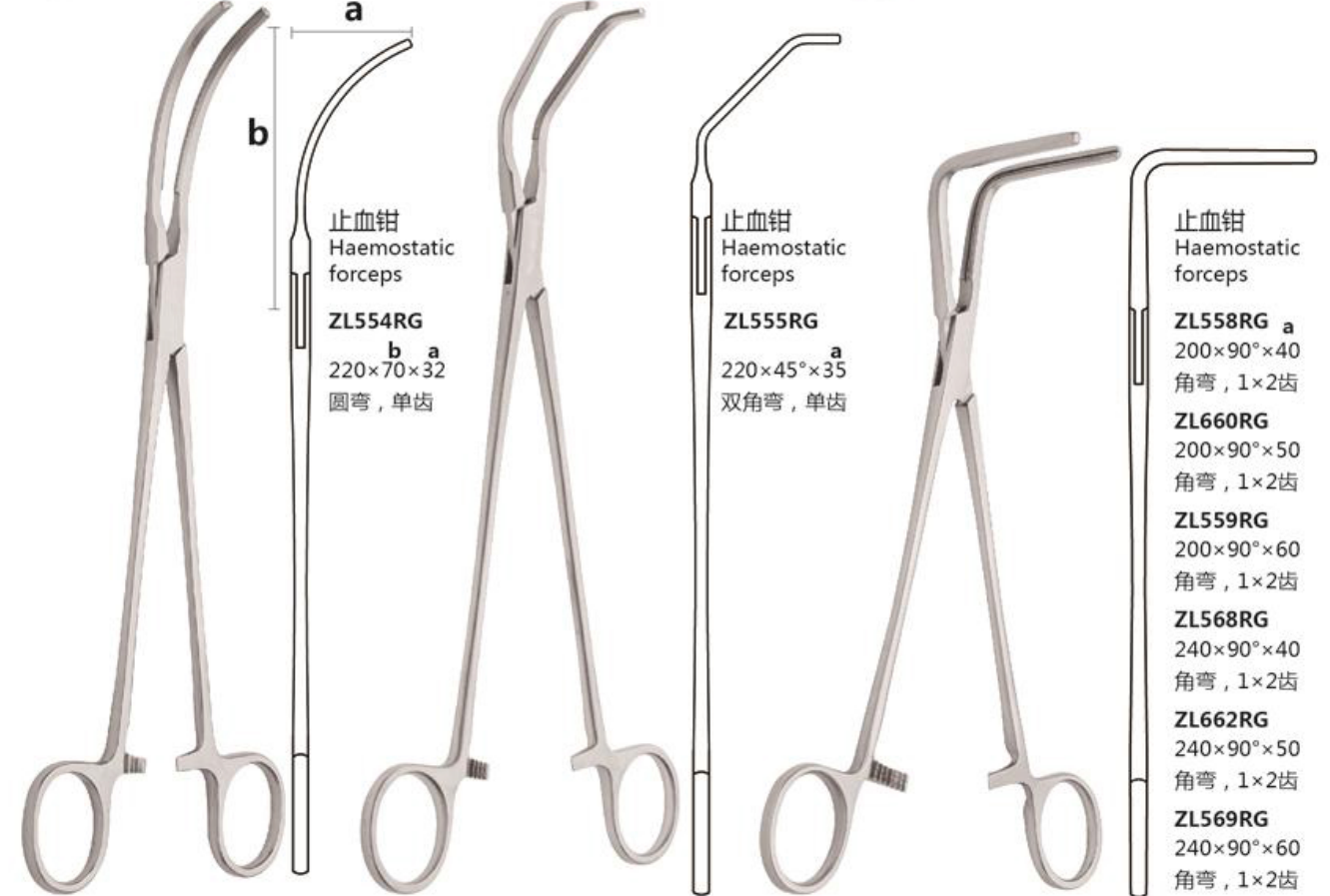

**止血钳**  
Haemostatic forceps

**ZL554RG**  
220×70×32  
圆弯, 单齿

**止血钳**  
Haemostatic forceps

**ZL555RG**  
220×45°×35  
双角弯, 单齿

**止血钳**  
Haemostatic forceps

**ZL558RG**  
200×90°×40  
角弯, 1×2齿

**ZL660RG**  
200×90°×50  
角弯, 1×2齿

**ZL559RG**  
200×90°×60  
角弯, 1×2齿

**ZL568RG**  
240×90°×40  
角弯, 1×2齿

**ZL662RG**  
240×90°×50  
角弯, 1×2齿

**ZL569RG**  
240×90°×60  
角弯, 1×2齿





止血钳  
Haemostatic forceps  
**ZL560RG**  
200, 直, 单齿  
**ZL565RG**  
220, 直, 单齿

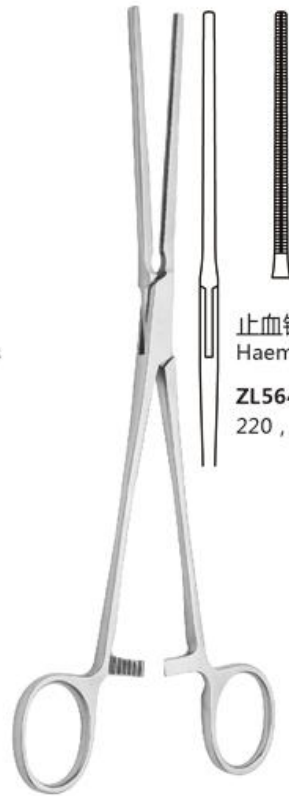

止血钳  
Haemostatic forceps  
**ZL564RG**  
220, 直, 双齿

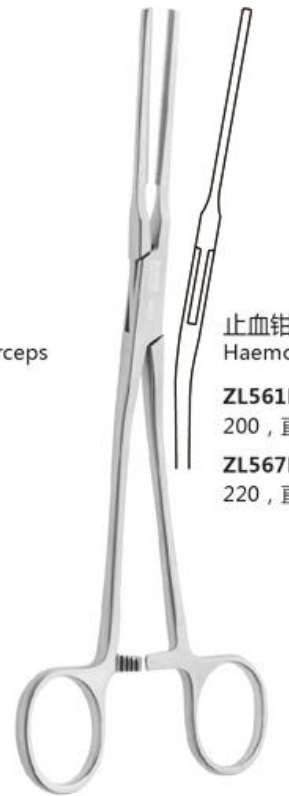

止血钳  
Haemostatic forceps  
**ZL561RG**  
200, 直, 弯柄, 单齿  
**ZL567RG**  
220, 直, 弯柄, 单齿



止血钳  
Haemostatic forceps  
**ZL557RG**  
180×50°×21, 双角弯, 双齿

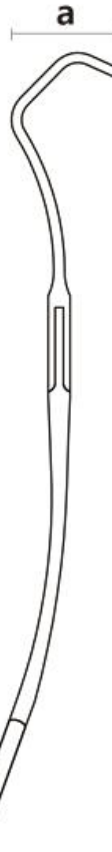

止血钳  
Haemostatic forceps  
**ZL570RG**  
260×50°×38, 角弯, 双齿



止血钳  
Haemostatic forceps  
**ZL661RG**  
220×30°×30, 角弯, 单齿



止血钳  
Haemostatic forceps  
**ZL665RG**  
220, 直, 弯柄, 1×2齿



胸腔镊  
Dressing forceps  
**ZD541R**  
200, 1×2钩  
**ZD541RN**  
200, 1×2钩



胸腔镊  
Dressing forceps  
**ZD581R**  
200, 2×3钩  
**ZD581RN**  
200, 2×3钩



胸腔镊  
Dressing forceps  
curved, without hook  
**ZD243R**  
200, 弯无钩  
**ZD243RN**  
200, 弯无钩



胸腔镊  
Dressing forceps  
curved, without hook  
**ZD246R**  
200, 直无钩  
**ZD246RN**  
200, 直无钩



熊掌镊  
Forceps with  
serrated jaw, straight  
**ZD248RG**  
150×7, 直



熊掌镊  
Forceps with  
serrated jaw, straight  
**ZD249RG**  
200×8, 直  
**ZD247RG**  
230×6.5, 直

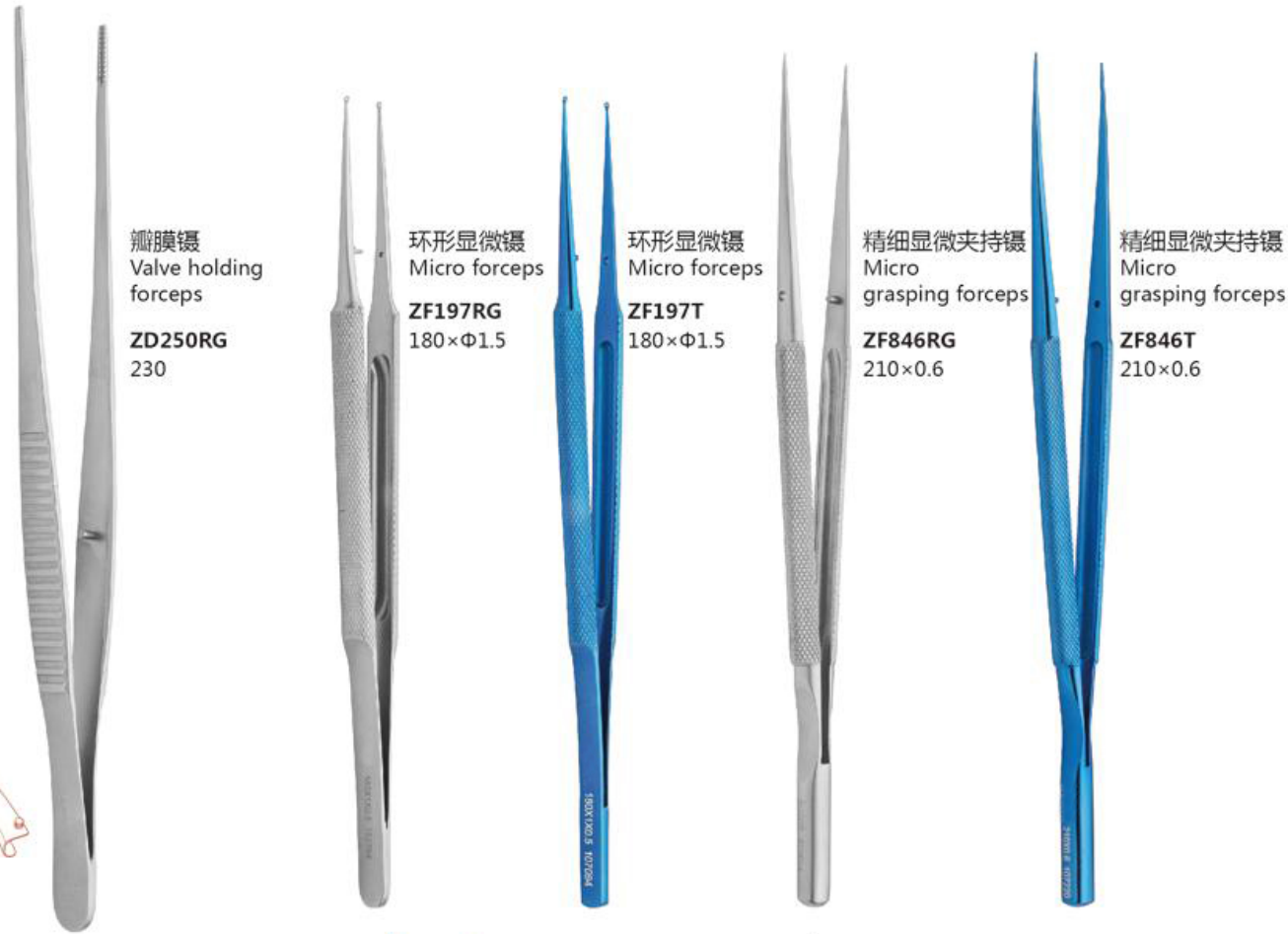

瓣膜镊  
Valve holding  
forceps

**ZD250RG**  
230

环形显微镊  
Micro forceps

**ZF197RG**  
180×Φ1.5

环形显微镊  
Micro forceps

**ZF197T**  
180×Φ1.5

精细显微夹持镊  
Micro  
grasping forceps

**ZF846RG**  
210×0.6

精细显微夹持镊  
Micro  
grasping forceps

**ZF846T**  
210×0.6

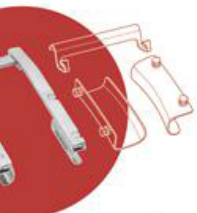

胸腔心血管  
Cardiovascular Instruments

胸腔心血管  
Cardiovascular Instruments

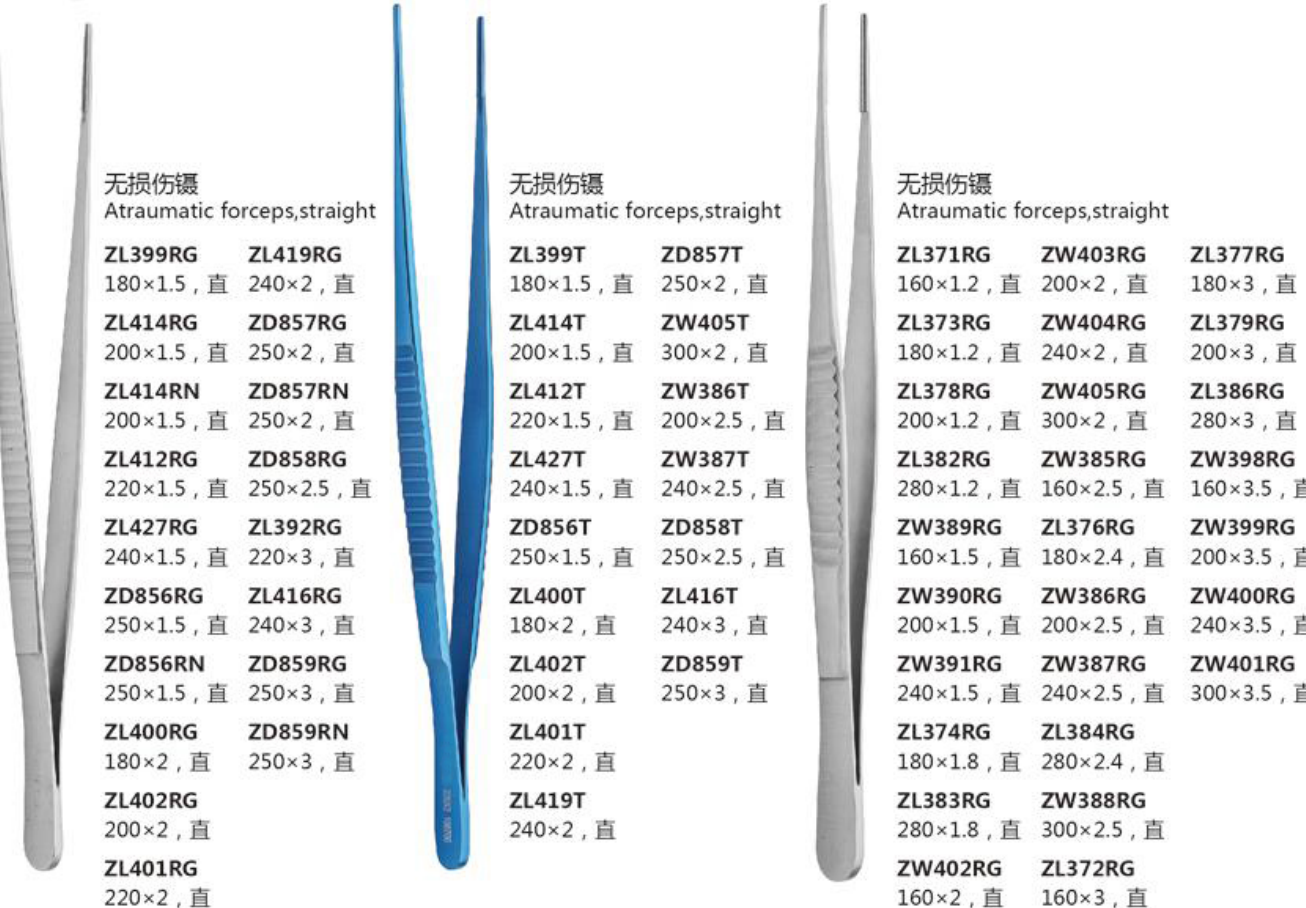

无损伤镊  
Atraumatic forceps, straight

**ZL399RG** 180×1.5, 直  
**ZL414RG** 200×1.5, 直  
**ZL414RN** 200×1.5, 直  
**ZL412RG** 220×1.5, 直  
**ZL427RG** 240×1.5, 直  
**ZD856RG** 250×1.5, 直  
**ZD856RN** 250×1.5, 直  
**ZL400RG** 180×2, 直  
**ZL402RG** 200×2, 直  
**ZL401RG** 220×2, 直

无损伤镊  
Atraumatic forceps, straight

**ZL399T** 180×1.5, 直  
**ZL414T** 200×1.5, 直  
**ZL412T** 220×1.5, 直  
**ZL427T** 240×1.5, 直  
**ZD856T** 250×1.5, 直  
**ZL400T** 180×2, 直  
**ZL402T** 200×2, 直  
**ZL401T** 220×2, 直  
**ZL419T** 240×2, 直

无损伤镊  
Atraumatic forceps, straight

**ZL371RG** 160×1.2, 直  
**ZL373RG** 180×1.2, 直  
**ZL378RG** 200×1.2, 直  
**ZL382RG** 280×1.2, 直  
**ZW389RG** 160×1.5, 直  
**ZW390RG** 200×1.5, 直  
**ZW391RG** 240×1.5, 直  
**ZL374RG** 180×1.8, 直  
**ZL383RG** 280×1.8, 直  
**ZW402RG** 160×2, 直

**ZW403RG** 200×2, 直  
**ZW404RG** 240×2, 直  
**ZW405RG** 300×2, 直  
**ZW385RG** 160×2.5, 直  
**ZL376RG** 180×2.4, 直  
**ZW386RG** 200×2.5, 直  
**ZW387RG** 240×2.5, 直  
**ZL384RG** 280×2.4, 直  
**ZW388RG** 300×2.5, 直  
**ZL372RG** 160×3, 直

无损伤镊 (乳内镊)  
Atraumatic forceps, curved

**ZL417T** 240×1.5×40°  
**ZL418T** 240×2×40°

无损伤镊  
Atraumatic forceps  
curved

**ZW392RG** 160×2×45°  
**ZW393RG** 200×2×45°  
**ZW394RG** 240×2×45°  
**ZW395RG** 300×2×45°

无损伤镊  
Atraumatic forceps, straight

**ZL1900RB** 150×1.6, 镶片  
**ZL1902RB** 240×1.6, 镶片  
**ZL1903RB** 150×2, 镶片  
**ZL1905RB** 240×2, 镶片

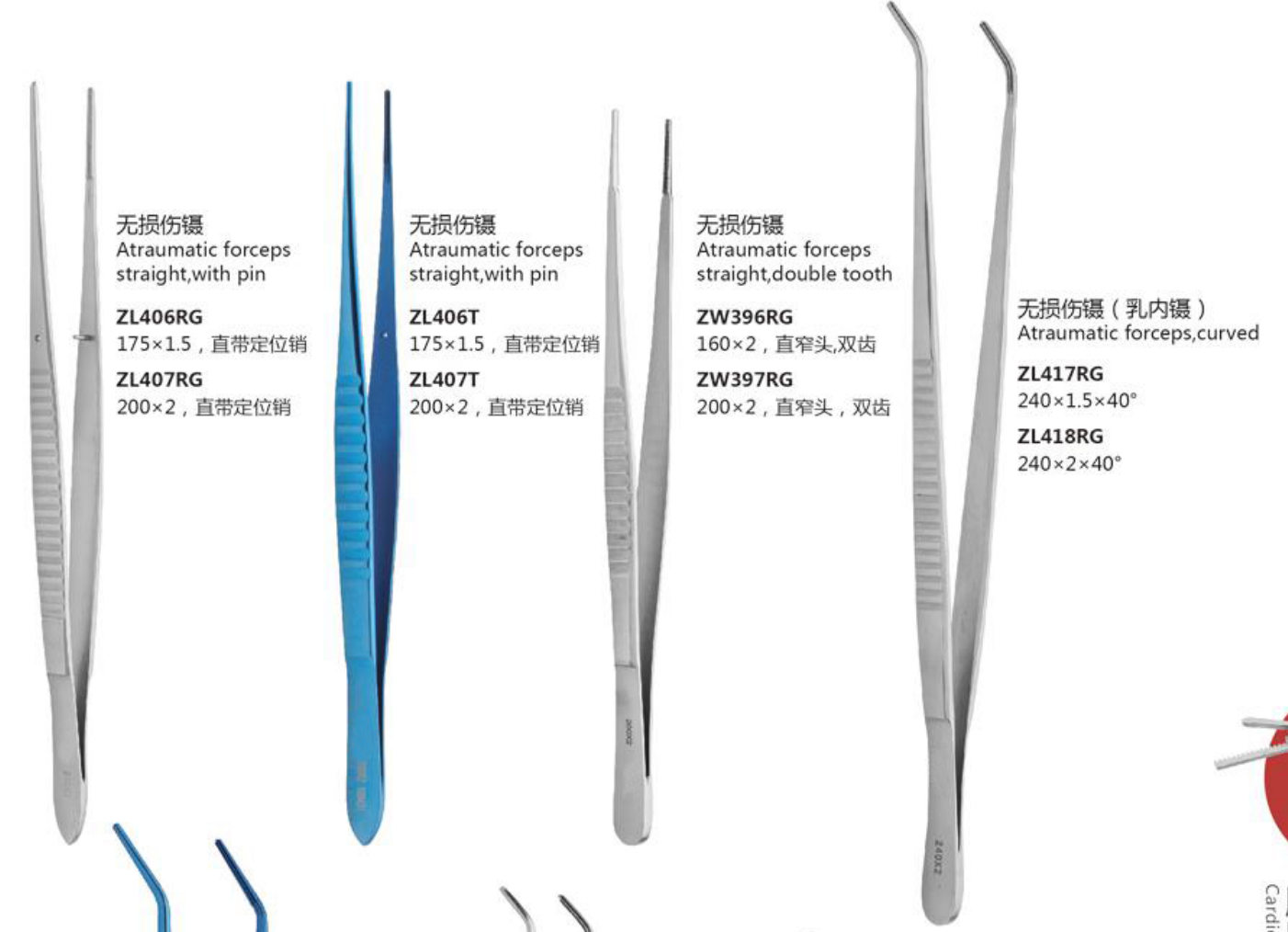

无损伤镊  
Atraumatic forceps  
straight, with pin

**ZL406RG** 175×1.5, 直带定位销  
**ZL407RG** 200×2, 直带定位销

无损伤镊  
Atraumatic forceps  
straight, with pin

**ZL406T** 175×1.5, 直带定位销  
**ZL407T** 200×2, 直带定位销

无损伤镊  
Atraumatic forceps  
straight, double tooth

**ZW396RG** 160×2, 直窄头, 双齿  
**ZW397RG** 200×2, 直窄头, 双齿

无损伤镊 (乳内镊)  
Atraumatic forceps, curved

**ZL417RG** 240×1.5×40°  
**ZL418RG** 240×2×40°

胸腔心血管  
Cardiovascular Instruments

胸腔心血管  
Cardiovascular Instruments



显微止血夹  
Haemostatic clip, straight

- ZL511RG**  
4cm反力式, 直, 横齿
- ZL513RG**  
5cm反力式, 直, 横齿
- ZL515RG**  
6cm反力式, 直, 横齿
- ZL517RG**  
7cm反力式, 直, 横齿



显微止血夹  
Haemostatic clip, curved

- ZL512RG**  
4cm反力式, 弯, 横齿
- ZL514RG**  
5cm反力式, 弯, 横齿
- ZL516RG**  
6cm反力式, 弯, 横齿
- ZL518RG**  
7cm反力式, 弯, 横齿
- ZL519RG**  
8cm反力式, 弯, 横齿



凹凸齿止血夹  
Atraumatic clip

- ZL429RG**  
6cm反力式, 弯, 1×2齿



显微止血夹  
Haemostatic clip

- ZF2211RN**  
50 弯 横齿



凹凸齿止血夹  
Atraumatic clip

- ZL1330RB**  
50 反力式 直10
- ZL1332RB**  
50 反力式 直14
- ZL1334RB**  
60 反力式 直20



凹凸齿止血夹  
Atraumatic clip

- ZL1331RB**  
50 反力式 角弯10
- ZL1333RB**  
50 反力式 角弯14
- ZL1335RB**  
60 反力式 角弯



凹凸齿止血夹  
Atraumatic clip, straight

- ZL423RG**  
65 直
- ZL425RG**  
75 直



凹凸齿止血夹  
Atraumatic clip, curved

- ZL424RG**  
65 弯
- ZL428RG**  
75 弯



凹凸齿止血夹  
Atraumatic clip, curved

- ZL426RG**  
75 弯



凹凸齿止血夹  
Atraumatic clip

- ZL1360RB**  
70×23 可调式 双角弯



凹凸齿止血夹  
Atraumatic clip

- ZL1361RB**  
90 可调式 双圆弯



凹凸齿止血夹  
Atraumatic clip

- ZL1362RB**  
100×20 可调式 双角弯



凹凸齿止血夹  
Atraumatic clip

- ZL1363RB**  
50×30 可调式 角弯



凹凸齿止血夹  
Atraumatic clip

- ZL1367RB**  
110 左弯
- ZL1368RB**  
110 右弯



凹凸齿止血夹  
Atraumatic clip

- ZL1373RB**  
70×12 反力式 圆弯
- ZL1374RB**  
80×15 反力式 圆弯
- ZL1375RB**  
100×20 反力式 圆弯
- ZL1376RB**  
115×24 反力式 圆弯



凹凸齿止血夹  
Atraumatic clip

- ZL1381RB**  
55×15 可调式 圆弯
- ZL1382RB**  
65×18 可调式 圆弯
- ZL1383RB**  
85×18 可调式 圆弯
- ZL1384RB**  
105×20 可调式 圆弯



凹凸齿止血夹  
Atraumatic clip

- ZL1364RB**  
70×26 反力式 角弯



凹凸齿止血夹  
Atraumatic clip

- ZL1369RB**  
75 反力式 直
- ZL1370RB**  
85 反力式 直
- ZL1371RB**  
105 反力式 直
- ZL1372RB**  
120 反力式 直



凹凸齿止血夹  
Atraumatic clip

- ZL1377RB**  
60 可调式 直
- ZL1378RB**  
70 可调式 直
- ZL1379RB**  
90 可调式 直
- ZL1380RB**  
110 可调式 直



器械钳  
Nerve retractor

- ZL1385RB**  
230



神经钩  
Nerve retractor

- ZT095RG**  
200×90°×8×Φ0.8

- ZT096RG**  
240×90°×12×Φ0.8

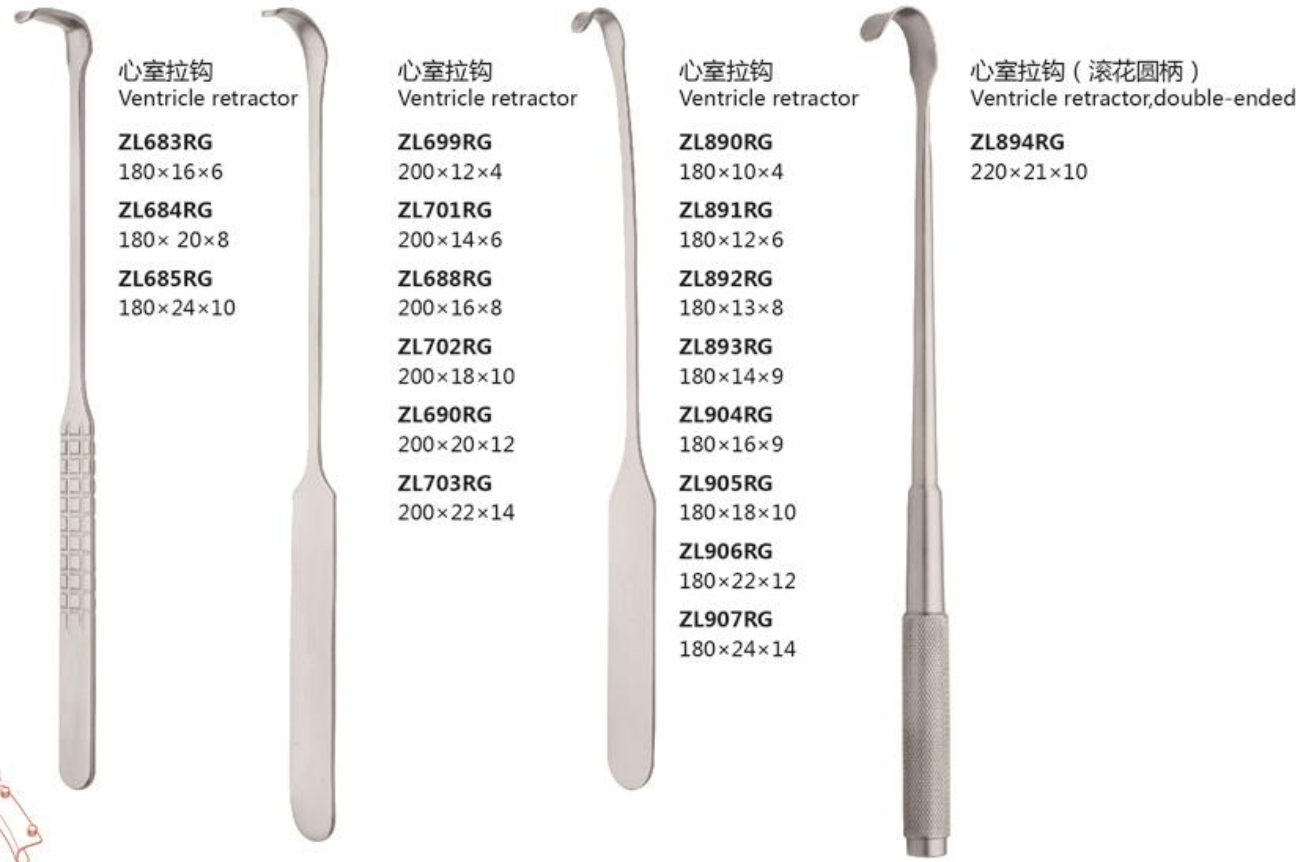

胸腔心血管  
Cardiovascular Instruments



胸腔心血管  
Cardiovascular Instruments



心室拉钩  
Ventricle retractor

**ZL909RG**  
200, 双头, 28×5/30×4.5

心室拉钩  
Ventricle retractor

**ZL910RG**  
200, 双头, 34×3.5/31×8.5

心室拉钩  
Ventricle retractor

**ZL914RG**  
200×21×20  
**ZL915RG**  
200×17×15  
**ZL916RG**  
200×13×10

心房拉钩  
Atrium retractor

**ZL704RG**  
230×45×22  
**ZL705RG**  
230×45×32  
**ZL706RG**  
230×45×42

主动脉拉钩  
Artery retractor, double-ended

**ZL708R**  
180, 头宽7  
**ZL708RG**  
180, 头宽7  
**ZL709R**  
180, 头宽9  
**ZL709RG**  
180, 头宽9

主动脉拉钩  
Artery retractor, double-ended

**ZL710RG**  
210, 17×14/38×14

主动脉拉钩  
Artery retractor, double-ended

**ZL711RG**  
185, 20×16/20×16  
**ZL712RG**  
170, 26×23/23×23

胸腔心血管  
Cardiovascular Instruments



瓣膜腱索拉钩  
Hook

**ZL748RG**  
240×11×90°

二尖瓣膜拉钩  
Dilator for mitral valve

**ZL749RG**  
240

可塑性挡板  
Spatula, malleable

**ZL717RG**  
200×10×6  
**ZL718RG**  
210×12×7  
**ZL719RG**  
220×14×8  
**ZL720RG**  
230×16×9  
**ZL721RG**  
250×20×11  
**ZL722RG**  
270×24×13

可塑性挡板 (心内拉钩)  
Cardio hook

**ZL724RN**  
250×5  
**ZL725RN**  
250×10  
**ZL726RN**  
250×15  
**ZL727RN**  
250×20

心脏静脉拉钩  
Vein retractor

**ZL716RG**  
300×8

肩胛骨拉钩  
Scapula retractor

**ZT531R**  
125/80×70

心内吸引器  
Cardio suction cannula

**ZL671RG**  
30, Φ18, 球头

胸腔心血管  
Cardiovascular Instruments



胸腔心血管  
Cardiovascular Instruments



心内吸引器  
Cardio suction cannula

**ZL673RG**  
180×Φ3  
**ZL674RG**  
180×Φ4



胸腔吸引管  
Suction tube

**ZN944R**  
270



心内吸引器  
Cardio suction cannula

**ZL672RG**  
180×Φ4×90°



胸腔吸引管  
Suction cannula for thoracic cavity

**ZL666RG**  
300, Φ6, Φ8



胸腔吸引管  
Cardio suction cannula

**ZL670RG**  
250, 角弯, 30°, 冠状动脉



心脏探子  
Heart probe, double-ended

**ZL222RG**  
双头, Φ3 / Φ4  
**ZL223RG**  
双头, Φ5 / Φ6  
**ZL224RG**  
双头, Φ7 / Φ8  
**ZL225RG**  
双头, Φ9 / Φ10  
**ZL226RG**  
双头, Φ11 / Φ12  
**ZL227RG**  
双头, Φ13 / Φ14  
**ZL228RG**  
双头, Φ15 / Φ16  
**ZL229RG**  
双头, Φ17 / Φ18  
**ZL230RG**  
双头, Φ19 / Φ20



双头骨膜剥离器  
Periosteal elevator

**ZK420R**  
250, 头宽圆12/方12  
**ZK420RN**  
250, 头宽圆12/方12



剥离子  
Dissector, double ended

**ZO172RG**  
180×1.2/2



肋骨骨膜剥离器  
Rib raspator

**ZK408R**  
180, 左式, 头部24×35  
**ZK408RN**  
180, 左式, 头部24×35



双头骨膜剥离器  
Periosteal elevator

**ZK421R**  
220, 头V形宽10/方圆12  
**ZK421RN**  
220, 头V形宽10/方圆12



肋骨骨膜剥离器  
Rib raspator

**ZK409R**  
180, 右式, 头部24×35



胸腔心血管  
Cardiovascular Instruments





肋骨合拢器  
Rib contractor  
**ZL842R**  
170



肋骨打孔器  
Rib punch  
**ZL884R**  
200×2  
**ZL884RN**  
200×2



血管探针 (血管扩张器)  
Vessel dilator  
**ZL1300RB**  
190×Φ0.5  
**ZL1301RB**  
190×Φ1



胸腔穿刺针  
Puncture needle for thoracic cavity  
**ZL212R**  
12#  
**ZL216R**  
16#



胸骨穿刺针 (胸骨穿刺针)  
Puncture needle for sternum  
**ZL219R**  
12#  
**ZL220R**  
16#



引线器  
Wire guide  
**ZM784RG**  
260×0.5  
**ZM786RG**  
260×1  
**ZM785RG**  
260×2



乳突牵开器  
Self-retaining retractor  
**ZV073RG**  
170×21, 3×3 钝钩 (活节带齿)

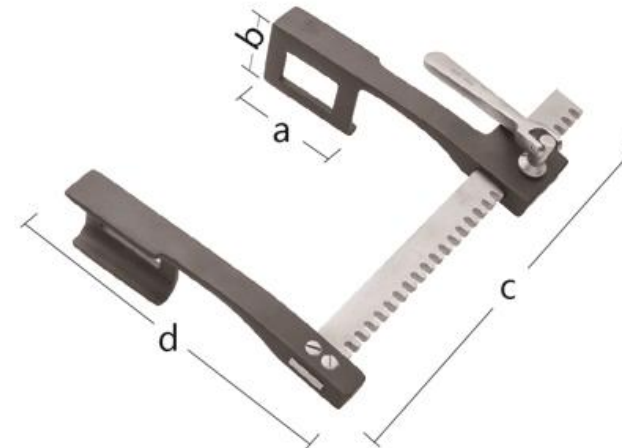

肋骨牵开器  
Rib spreader  
**ZL802R**  
a b c d  
40×34, 200×140, 小号  
**ZL803R**  
60×52, 240×170, 中号  
**ZL804R**  
75×65, 300×210, 大号



肋骨牵开器  
Rib spreader  
**ZL843RG**  
60×50, 240×170, 中号, 左式

胸腔心血管  
Cardiovascular Instruments

胸腔心血管  
Cardiovascular Instruments

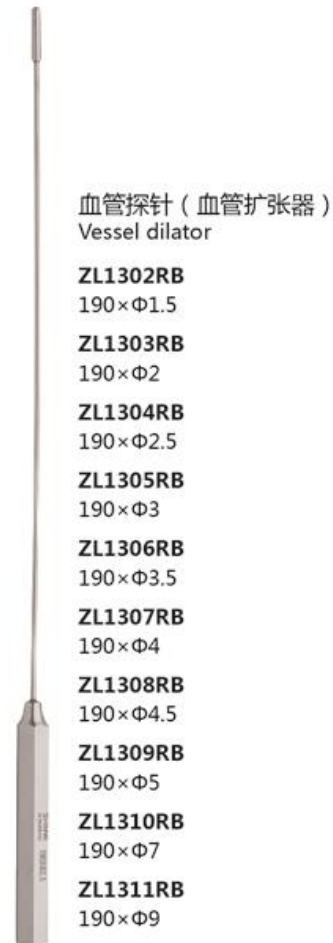

血管探针 (血管扩张器)  
Vessel dilator  
**ZL1302RB**  
190×Φ1.5  
**ZL1303RB**  
190×Φ2  
**ZL1304RB**  
190×Φ2.5  
**ZL1305RB**  
190×Φ3  
**ZL1306RB**  
190×Φ3.5  
**ZL1307RB**  
190×Φ4  
**ZL1308RB**  
190×Φ4.5  
**ZL1309RB**  
190×Φ5  
**ZL1310RB**  
190×Φ7  
**ZL1311RB**  
190×Φ9



探针  
Probe, double ended  
**ZM103AG**  
120, 双头, 银  
**ZM114R**  
140, 双头  
**ZM120R**  
200, 双头  
**ZM120AG**  
200, 双头, 银



探针  
Probe  
**ZM121AG**  
200×2.5, 单头, 银



胸腔引流套管针  
Drainage trocar for thoracic cavity  
**ZL192C**  
50#  
**ZL193C**  
65#  
**ZL194C**  
80#



胸骨(乳内)牵开器  
Sternum spreader for adult  
**ZL800RG**  
215×200



乳内牵开器  
Sternum spreader for adult

**ZL801RG**  
100×24, 20×36, 20×32, 20×28, 250×190  
四活叶带齿, 转动

乳内牵开器  
Sternum spreader for adult

**ZL801T**

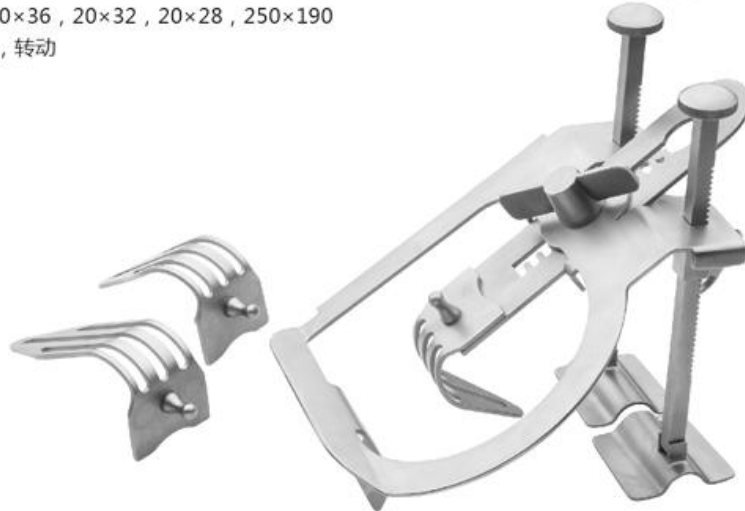

胸骨牵开器  
Sternum spreader  
**ZL806RG**  
框式



胸骨牵开器  
Sternum spreader for children

**ZL837RG**  
21×21, 110×85, 小儿



胸骨牵开器  
Sternum spreader for children

**ZL788RG**  
15×12, 110×63, 小儿, 单叶翻转

**ZL789RG**  
20×16, 110×63, 小儿, 单叶翻转

**ZL764RG**  
30×18, 160×106

**ZL791RG**  
50×18, 140×116, 小儿, 单叶翻转

**ZL763RG**  
50×30, 180×125, 单叶翻转



胸骨牵开器  
Sternum spreader for children

**ZL756RG**  
20×45, 160×130, 小儿

**ZL757RG**  
20×55, 160×130, 小儿

**ZL762RG**  
30×45, 160×130, 小儿

**ZL761RG**  
30×55, 160×130, 小儿

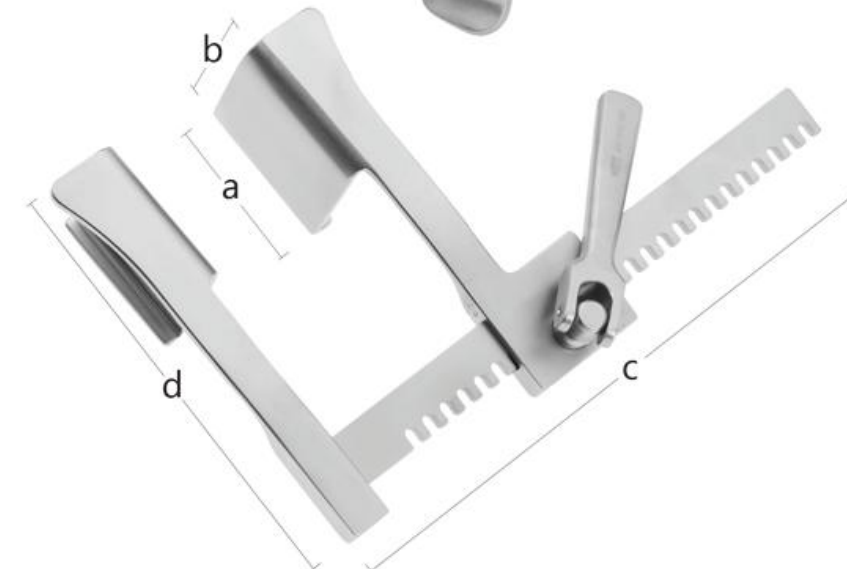

胸骨牵开器  
Sternum spreader for children

**ZL838RG**  
a b c d  
25×23, 180×118, 小儿

**ZL839RG**  
30×35, 180×118

**ZL840RG**  
44×55, 180×118, 小儿



胸骨牵开器  
Sternum spreader for children

**ZL841RG**  
a b a b a b c d  
24×30, 28×35, 32×40, 140×113, 小儿

胸骨牵开器  
Sternum spreader for children

**ZL792RG**  
30×24, 160×100, 小儿, 单叶可转



胸骨牵开器  
Sternum spreader for children

**ZL825RG**  
18×16, 108×78, 小儿  
**ZL826RG**  
25×22, 140×105, 小儿  
**ZL767RG**  
45×25, 210×140  
**ZL768RG**  
50×36, 260×180

胸骨牵开器  
Sternum spreader for adult

**ZL776RG**  
48×42, 300×200, 成人



胸腔心血管  
Cardiovascular Instruments



胸骨牵开器  
Sternum spreader for children

**ZL834RG**  
15×14, 110×158, 小儿, 双叶可转



胸骨牵开器  
Sternum spreader for children

**ZL836RG**  
13×16, 110×105, 小儿, 多叶可转



胸骨牵开器  
Sternum spreader

<b>ZL795RG</b> 34×14, 108×72, 新生儿 for infant	<b>ZL797RG</b> 60×20, 150×150, 小儿 for children
<b>ZL796RG</b> 48×15, 140×96, 婴幼儿 for infant	<b>ZL805RG</b> 70×38, 210×155
<b>ZL794RG</b> 30×20, 150×150, 小儿 for children	<b>ZL798RG</b> 95×42, 300×200, 成人 for adult



胸腔心血管  
Cardiovascular Instruments



胸骨牵开器  
Sternum spreader for children

**ZL771RG**  
16×15, 110×67, 小儿  
**ZL772RG**  
18×18, 110×78, 小儿  
**ZL773RG**  
25×22, 140×96, 小儿  
**ZL774RG**  
28×32, 140×106, 小儿



胸骨牵开器  
Sternum spreader for children

**ZL824RG**  
40×35, 210×145, 小儿  
**ZL769RG**  
65×50, 260×200  
**ZL770RG**  
65×65, 260×220

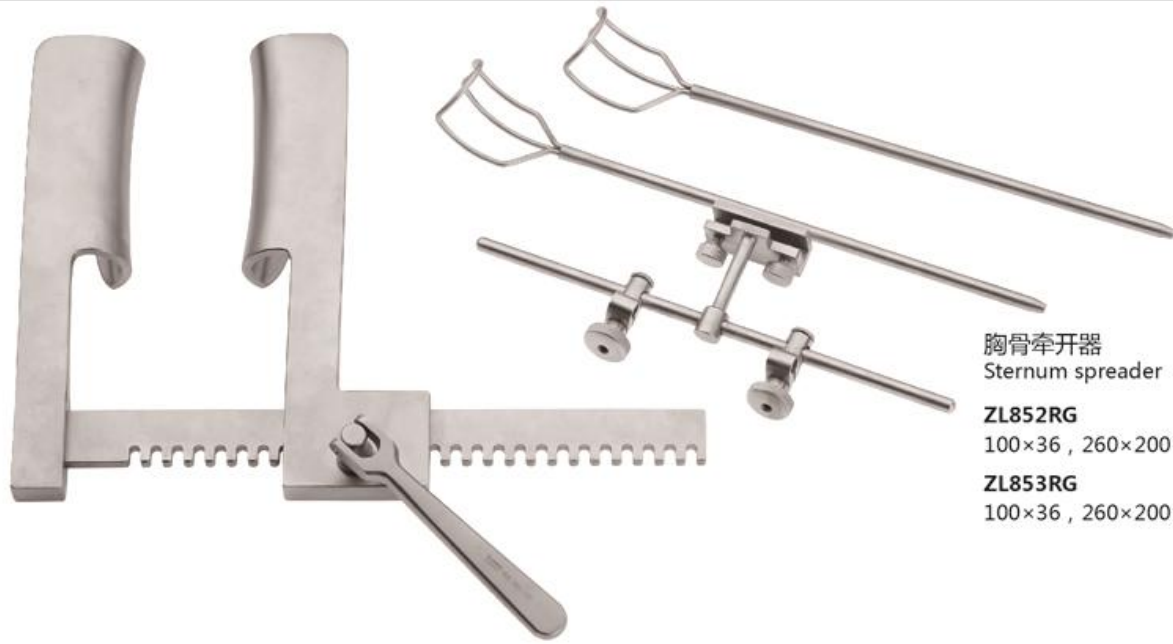

胸骨牵开器  
Sternum spreader  
**ZL852RG**  
100×36, 260×200  
**ZL853RG**  
100×36, 260×200, 带附件



胸骨牵开器  
Sternum spreader

**ZL777RG**  
15×15, 180×116, 小儿, 双叶可转  
for children, double blades, detachable

**ZL835RG**  
18×22, 180×150, 小儿, 双叶可转  
for children, double blades, detachable

**ZL778RG**  
20×21, 180×145, 小儿, 双叶可转  
for children, double blades, detachable

**ZL855RG**  
23×28, 260×180, 双叶可转  
double blades, detachable

**ZL856RG**  
28×27, 260×200, 双叶可转  
double blades, detachable

**ZL857RG**  
28×43, 260×200, 双叶可转  
double blades, detachable

**ZL812RG**  
30×24, 160×150, 小儿, 双叶可转  
for children, double blades, detachable

**ZL822RG**  
33×27, 250×160, 双叶可转  
double blades, detachable

**ZL779RG**  
30×45, 300×185, 成人, 双叶可转  
for adult, double blades, detachable

**ZL811RG**  
37×30, 300×185, 成人, 双叶可转  
for adult, double blades, detachable



胸骨牵开器  
Sternum spreader  
**ZL854RG**  
67×45, 67×85, 260×220  
单叶可拆、可换



胸骨牵开器  
Sternum spreader  
**ZL787RG**  
75×30, 210×170  
**ZL827RG**  
90×30, 250×190



胸骨牵开器  
Sternum spreader, double blades, detachable

**ZL858RG**  
35×23, 240×205, 双叶可转

**ZL821RG**  
35×30, 240×205, 双叶可转

胸骨牵开器  
Sternum spreader, double blades, detachable

**ZL859RG**  
35×23, 240×205, 双叶移动

**ZL860RG**  
35×30, 240×205, 双叶移动



胸骨牵开器  
Sternum spreader for adult,moveable

**ZL813RG**  
37×30, 300×195, 成人, 双叶移动

**ZL829RG**  
30×45, 275×195, 成人, 双叶移动

**ZL828RG**  
37×30, 250×160, 双叶移动

**ZL830RG**  
30×45, 250×160, 双叶移动

**ZL831RG**  
30×45, 275×180, 双叶移动

**ZL832RG**  
30×45, 300×195, 双叶移动



胸骨牵开器  
Sternum spreader ,double blades,detachable,moveable

**ZL819RG**  
40×60, 26×50, 280×225, 双叶可拆, 双向移动式



胸骨牵开器  
Sternum spreader ,double blades,detachable

**ZL820RG**  
40×60, 26×50, 280×225, 双叶可拆

**ZL823RG**  
40×48, 230×200, 双叶可拆



胸腔心血管  
Cardiovascular Instruments